

Mod. **PRA**

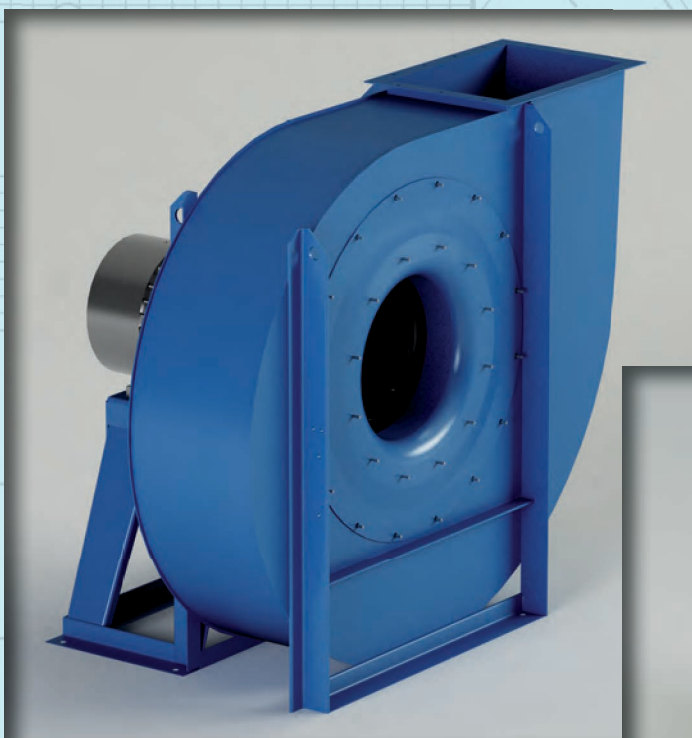

$Q = 1500 \div 140000 \text{ m}^3/\text{h}$

$Q = 0.4 \div 39 \text{ m}^3/\text{s}$

$p_t = 150 \div 1100 \text{ mmH}_2\text{O}$

$p_t = 1500 \div 11000 \text{ Pa}$

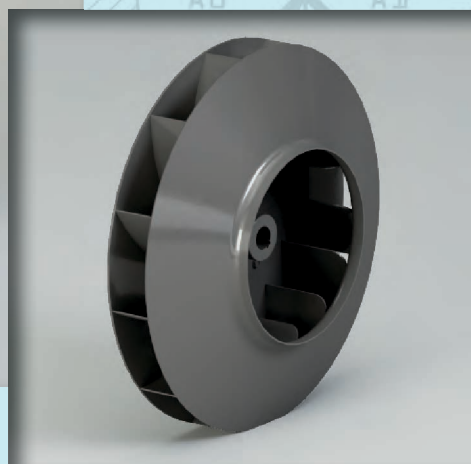

Campo di lavoro

Portate piccole-medie-alte. Pressioni medie.

Tipo di pala

Curva, rovescia (negativa), vedi pag. 2.2.

Applicazioni

Per trasporto pneumatico, fumi, polveri fini. Adatto al trasporto di materiali solidi in miscela con aria, trucioli e segatura con ventilatore non attraversato.

Esecuzioni costruttive standard

Es.1-Es.4-Es.5-Es.8-Es.9-Es.12, vedi pag. 2.5 - 2.6.

Temperature del fluido standard

-10÷+60°C. Per altre temperature vedi da pag. 1.12 a pag. 1.15.

Tipo di costruzione

Ventilatore in lamiera di Fe360, girante in Fe360 equilibrata staticamente e dinamicamente. Per altri materiali vedi da pag. 1.12 a pag. 1.15.

Dati di funzionamento

Condizioni dell'aria all'aspirazione T=20°C, 0m.s.l.m. e $\rho=1.205 \text{ kg/m}^3$.

Rumorosità

Espressa in potenza sonora L_{wA} [dB(A)] rilevata in campo libero con ventilatore canalizzato, vedi da pag. 1.43 a pag. 1.49.

Orientamenti

N°8 RD (rotazione oraria vista lato trasmissione) e N°8 LG. Ventilatore in versione imbullonata orientabile per le taglie 250-400, orientamento fisso per le taglie 450-1250. Vedi pag. 2.7.

Costruzioni speciali

Vedi da pag. 2.20 a pag. 2.34.

Classi giranti

La seguente tabella fa riferimento a condizioni di lavoro standard. In condizioni di esercizio gravose si consiglia di contattare il servizio clienti di CORAL per conoscere la tipologia di girante più idonea.

■ Domaine de travail

Débits petits-moyens-élevés. Moyennes pressions.

Type d'ailette

Courbée, inversée (négative), voir page 2.2.

Applications

Pour transport pneumatique, fumées, poussières fines. Convient au transport de matières solides en mélange dans l'air, copeaux et sciure avec ventilateur non traversé.

Configurations de constructions standard

Ex.1- Ex.4- Ex.5- Ex.8- Ex.9- Ex.12, voir pages 2.5 - 2.6.

Températures du fluide standard

-10÷+60°C. Pour d'autres températures voir pages 1.12-1.15.

Type de fabrication

Ventilateur en tôle de Fe360, turbine en Fe360 équilibrée statiquement et dynamiquement. Pour d'autres matériaux, voir pages 1.12-1.15.

Données de fonctionnement

Conditions de l'air à l'aspiration T=20°C, 0 m asl et $\rho=1.205 \text{ kg/m}^3$.

Niveau sonore

Exprimé en puissance sonore L_{wA} [dB(A)], relevé à l'air libre avec un ventilateur canalisé, voir pages 1.43 - 1.49.

Orientations

8 RD (rotation dans le sens des aiguilles d'une montre côté transmission) et 8 LG. Ventilateur en version boulonnée orientable pour les tailles 250-400, orientation fixe pour les tailles 450-1250. Voir page 2.7.

Fabrications spéciales

Voir pages 2.20-2.34.

Classes de turbines

Le tableau ci-dessus fait référence aux conditions de travail normales, en conditions de travail pénibles, on préconise de contacter le service clientèle de CORAL pour connaître le type de turbine le plus adapté.

PRAANDEZZA VENTILATORE • PRAandeur • Size • PRAöße • Tamaño	RPM MASSIMO • Maxi tours/min. • Max rpm • Max. U/min • R.p.m. máx.			
	CLASSE I	CLASSE II	CLASSE III	CLASSE IV
PRA250/R	4100	5800		
PRA250	4000	5600		
PRA280/R	3750	5400		
PRA280	3600	5000		
PRA320/R	3500	4750		
PRA320	3400	4500		
PRA360/R	3300	4250	4750	
PRA360	3200	4000	4500	
PRA400/R	3100	3750	4250	
PRA400	2970	3600	4000	
PRA450/R	2800	3400	3750	
PRA450	2600	3200	3550	
PRA500/R	2500	3000	3350	3570
PRA500	2350	2800	3150	3500
PRA560/R	2200	2650	3000	3300
PRA560	2100	2500	2800	3100
PRA630/R	2000	2350	2700	
PRA630	1900	2250	2550	
PRA700/R	1800	2150	2400	
PRA700	1700	2000	2250	
PRA800/R	1600	1900	2100	
PRA800	1500	1800	2000	
PRA900/R	1400	1700	1900	
PRA900	1300	1600	1800	
PRA1000	1100	1400	1600	
PRA1120	1200	1350	1460	
PRA1250	1000	1150	1250	

VALORI VALIDI FINO A 60°C

• Valeurs valables jusqu'à 60°C • Values valid up to 60°C
• Werte bis 60°C gültig • Valores válidos hasta 60°C

FRA • entre • between • zwischen • entre	E • et • and • und • y	DECLASSARE VELOCITÀ • déclasser vitesse • degrade speed • Geschwindigkeit herabsetzen • rebajar velocidad	4%
			100°C
150°C	16%		
200°C	23%		
250°C	30%		
300°C	37%		
350°C	45%		
400°C	54%		
450°C	64%		

■ Field of operation

Low-medium-high flow rates. Average pressures.

Blade type

Curve, backward (negative), see pg. 2.2.

Applications

For pneumatic transport, fumes, fine dust. Suitable for transporting solid materials mixed with air, chips and sawdust with a non-transited fan.

Standard constructional arrangements

Arr.1-Arr.4-Arr.5-Arr.8-Arr.9-Arr.12, see pgs. 2.5 - 2.6.

Standard fluid temperatures

-10÷+60°C. For other temperatures see pgs. 1.12 to 1.15.

Type of construction

Fan in Fe360 plate, impeller in Fe360 statically and dynamically balanced. For other materials see pgs. 1.12 to 1.15.

Operating specifications

Condition of inlet air T=20°C, 0 m above sea level and $\rho=1.205 \text{ kg/m}^3$.

Noise level

Expressed as sound power L_{wA} [dB(A)] measured in free field with ducted fan, see pgs. 1.43 to 1.49.

Orientations

No.8 RD (clockwise viewed from transmission side) and No.8 LG. Fan in bolted orientable version for sizes 250-400, fixed orientation for sizes 450-1250. See pg. 2.7.

Special applications

See pgs. 2.20 to 2.34.

Impeller classes

The above table refers to standard operating conditions, in heavy-duty service conditions it is advisable to contact the CORAL Customer Service to establish the most suitable type of impeller.

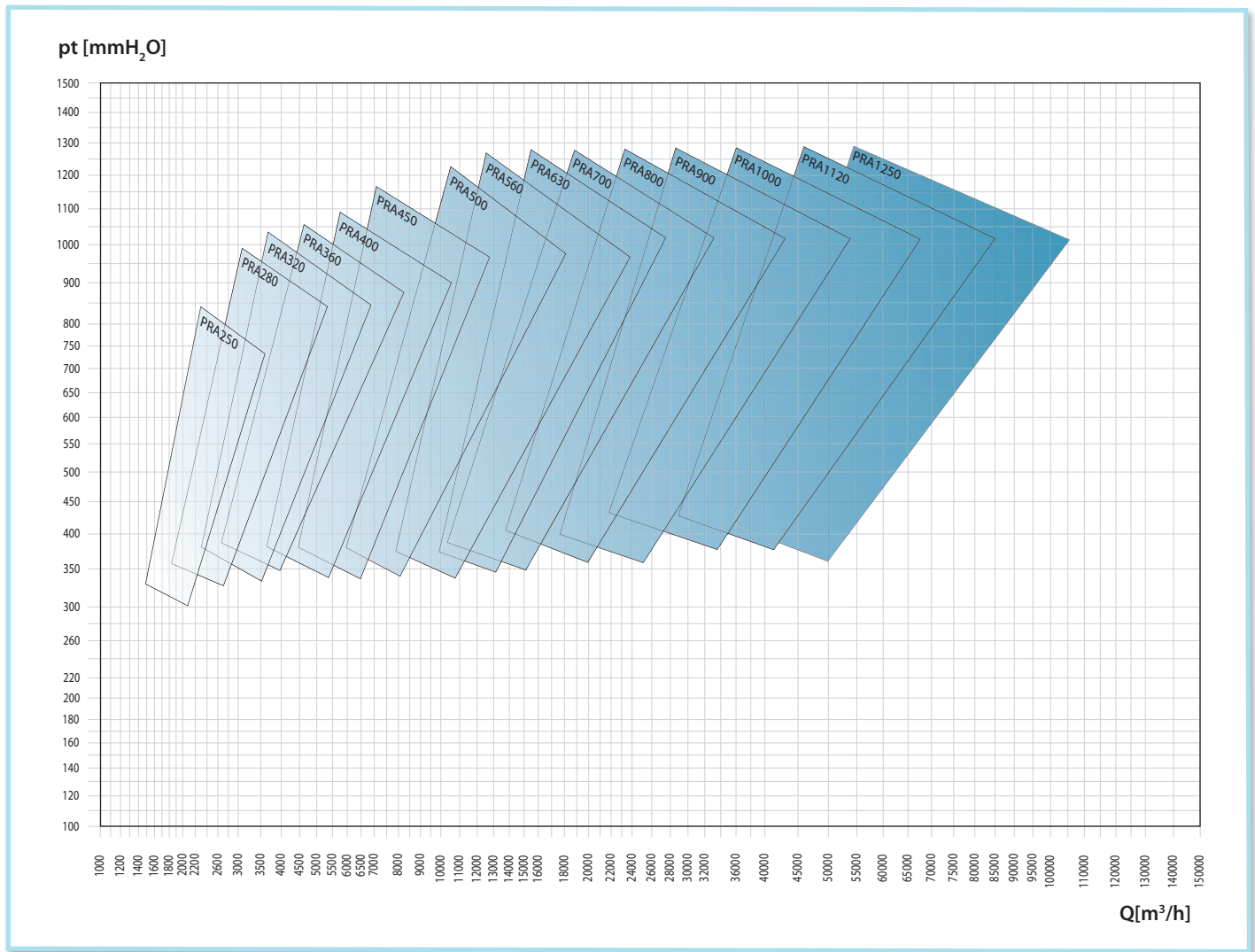

■ Arbeitsbereich

Niedrige - mittlere - grosse Fördermengen. Mittlere Drücke.

Schaufelform

Kurve, rückwärts gekrümmt (negativ), siehe Seite 2.2.

Anwendungen

Zum Transport von Luft, Rauch, Feinstaub. Zum Transport von in Luft enthaltenen Feststoffen, Spänen und Sägestaub bei nicht direkt durchströmten Ventilator geeignet.

Konstruktive Standardausführungen

Ausf. 1-Ausf. 4-Ausf. 5-Ausf. 8-Ausf. 9-Ausf. 12, siehe Seiten 2.5 - 2.6.

Standardtemperatur des Mediums

-10 ÷ +60°C. Für andere Temperaturen siehe Seiten 1.12 bis 1.15.

Konstruktionsart

Ventilator aus Blech Fe360, Laufrad aus Fe360, statisch und dynamisch ausgewuchtet. Für andere Materialien siehe Seiten 1.12 bis 1.15.

Betriebsdaten

Physikalischer Zustand der Ansaugluft T = 20°C, 0 m ü. M. und $\rho = 1.205 \text{ kg/m}^3$.

Geräuschpegel

angegeben als Schalleistungspegel L_{wA} [dB(A)] mit Messung im Freifeld und an Rohren angeschlossenem Ventilatore, siehe Seiten 1.43 bis 1.49.

Ausrichtung

8 Modelle RD (Drehrichtung im Uhrzeigersinn, von Antriebsseite aus gesehen) und 8 Modelle LG. Angeschraubter, in der Ausrichtung veränderbarer Ventilator in den Grössen 250-400, mit Vorderstütze und damit nicht veränderbar ab Grösse 450 mit Riementrieb, immer ausrichtbar bei allen direkt angetriebenen Ventilatoren ohne Vorderstütze, siehe Seite 2.7.

Spezialausführungen

Siehe Seiten 2.20 bis 2.34.

Laufradklassen

Die obenstehende Tabelle bezieht sich auf normale Betriebsbedingungen. Bei erschwerenden Betriebsbedingungen wird empfohlen, den Kundenservice der CORAL zu kontaktieren, um den am besten geeigneten Laufradtyp zu bestimmen.

■ Campo de trabajo

Caudales pequeños-medios-altos. Presiones medias.

Tipo de pala

Curva, invertida (negativa), ver pág. 2.2.

Aplicaciones

Para transporte neumático, humos y/o polvos finos. Apto para el transporte de materiales sólidos mezclados con aire, virutas y serrín sin transitar por el ventilador.

Variantes constructivas estándares

Ejec.1-Ejec.4-Ejec.5-Ejec.8-Ejec.9-Ejec.12, ver págs. 2.5 - 2.6.

Temperaturas del fluido estándares

De -10 a +60°C. Para otras temperaturas, ver págs. de 1.12 a 1.15.

Tipo de construcción

Ventilador de chapa en Fe360, rotor en Fe360 equilibrado estática y dinámicamente. Para otros materiales, ver págs. de 1.12 a 1.15.

Datos de funcionamiento

Condiciones del aire en aspiración T=20°C, 0 m SNM y $\rho = 1.205 \text{ kg/m}^3$.

Niveles de ruido

Expresados en potencia sonora L_{wA} [dB(A)] medida en campo abierto con ventilador canalizado, ver págs. de 1.43 a 1.49.

Orientaciones

8 RD (rotación dextrógira vista desde el lado de transmisión) y 8 LG. Ventilador en versión empennada orientable para tamaños 250-400, orientación fija para tamaños 450-1250. Ver pág. 2.7.

Construcciones especiales

Ver págs. de 2.20 a 2.34.

Clases de rotores

La tabla arriba hace referencia a condiciones de trabajo estándares, en condiciones de funcionamiento pesadas, se aconseja llamar al Servicio de atención al cliente de CORAL para conocer el tipo de rotor más adecuado.

Tipo • Type • Type • Typ • Tipo		P inst. [kW]	n	LpA [dB(A)]	Tolleranza sulla portata ±5% • Tolérance sur le débit ±5% • Load tolerance ±5% • Durchsatztoleranz ±5% • Tolerancia respecto caudal ±5%														
Ventilatore • Ventilateur • Fan • Ventilator • Ventilador	Motore • Moteur • Motor • Motor • Motor				Q [m³/h]														
					1440	1620	1800	1980	2160	2520	2880	3240	3600	3960	4320	4680	5400	6120	
					pt[mmH ₂ O]														
PRA250/2R	90	2,2	2920	65	258	256	253	249	244	233	219								
PRA250/2	100	3	2930	66	267	265	262	259	255	246	234	219	200						
PRA280/2R	112	4	2930	69				342	338	329	319	307	293	278	262				
PRA280/2	132	5,5	2950	72					359	354	346	336	324	310	295	277	238		
PRA320/2R	132	7,5	2950	77							412	407	400	391	375	368	337	300	
PRA320/2	160	11	2950	80							453	450	445	439	431	421	396	366	
PRA360/2R	160	11	2950	76									500	494	488	481	466	450	
PRA360/2	160	15	2960	84										541	535	529	517	502	
PRA400/2R	180	22	2960	84												623	613	601	
PRA400/2	200	30	2970	87													690	681	
PRA450/2R	200	37	2970	87															
PRA450/2	225	45	2970	87															
PRA500/2R	280	75	2970	91															
PRA500/2	280	90	2970	94															
PRA560/2R	315	132	2980	92															
PRA560/2	315	160	2980	98															
PRA360/4R	90	1,5	1420	62				114	113	110	105	101	95	90	83	75			
PRA360/4	100	2,2	1420	63				124	122	120	116	113	107	102	98	91	75		
PRA400/4R	100	3	1420	65						142	139	137	133	129	126	121	111	97	
PRA400/4	112	4	1440	68							161	159	156	153	151	147	137	128	
PRA450/4R	112	4	1440	69									186	183	180	178	172	164	
PRA450/4	132	5,5	1455	70										214	213	211	206	201	
PRA500/4R	132	7,5	1455	69												255	252	247	
PRA500/4	160	11	1460	77													276	272	
PRA560/4R	160	15	1460	78															
PRA560/4	180	22	1470	81															
PRA630/4R	200	30	1470	82															
PRA630/4	225	37	1480	86															
PRA700/4R	225	45	1480	83															
PRA700/4	250	55	1480	87															
PRA800/4R	280	75	1480	89															
PRA800/4	315	110	1485	94															
PRA900/4R	315	132	1485	92															
PRA900/4	315	160	1485	95															
PRA560/6R	132	4	950	64												138	136	133	
PRA560/6	132	5,5	950	69													148	145	
PRA630/6R	160	7,5	960	71														172	
PRA630/6	160	11	960	73															
PRA700/6R	180	15	970	74															
PRA700/6	200	18,5	975	77															
PRA800/6R	200	22	975	79															
PRA800/6	225	30	975	81															
PRA900/6R	250	37	980	83															
PRA900/6	280	55	980	86															

Il livello di pressione sonora ponderato A, LpA (cap.14), corrisponde al valore rilevato, nelle condizioni di prova, nel punto di massima rumorosità.

Tolleranza sulla rumorosità ±4dB(A)

- Tolérance sur le bruit ±4dB(A) • Noise tolerance ±4dB(A)
- Geräushtoleranz ±4dB(A) • Tolerancia respecto a ruido ±4dB(A)

Q [m³/h]																							
7200	7920	8640	9360	10800	12600	14400	16200	18000	19800	21600	25200	28800	32400	36000	39600	43200	46800	54000	61000	72000	79200		
pt[mmH₂O]																							
235																							
311	269	223																					
420	396	369																					
477	457	435	407	340	257																		
582	568	552	534	493	430	352																	
666	655	642	627	594	546	486	413	328															
792	782	771	760	735	697	652	600	538	465														
	898	888	879	858	829	795	756	710	657	597													
				1047	1026	1002	974	943	909	869	776	661											
				1145	1126	1106	1080	1054	1025	994	912	820	714	591									
						1358	1340	1321	1300	1277	1226	1164	1093	1009									
							1448	1437	1427	1400	1356	1315	1240	1162	1080	1000	895						
108	94																						
152	142	127	115																				
190	180	174	163	140																			
240	234	228	221	204																			
266	261	256	251	238	219	195	167	133															
326	322	318	314	303	295	275	256	240	214														
	353	350	346	339	327	314	299	281	261	238	182												
			403	397	388	378	367	354	339	322	276	234											
				443	435	427	417	406	394	384	349	310	263	208									
						501	493	485	475	465	439	409	374	333									
							562	555	548	540	520	497	469	439	403	363	318						
										627	613	595	575	551	525	495	462	385					
											708	697	683	666	648	627	603	577	517	448	318		
													780	747	753	736	718	698	652	599	497		
														892	883	872	859	846	830	795	755	680	620
128	124	122	118	107																			
140	138	135	131	122	110	92																	
168	166	164	162	155	145	136	121	103															
186	185	184	180	175	167	158	143	135	122	108													
		217	216	214	206	200	192	182	171	158	129												
			246	243	240	236	227	217	214	200	180	155	122										
					277	274	271	262	257	251	231	214	197	163									
						306	302	298	293	287	275	260	238	220	195	158	138						
							347	343	336	333	326	312	303	284	265	245	221						
									387	382	377	368	354	346	329	316	302	262	207				

■ Le niveau de pression sonore pondérée A, LpA (chap. 14), correspond à la valeur relevée dans les conditions d'essai au point de niveau sonore maximum.

■ Der nach A bewertete Schalldruckpegel LpA (Kap. 14) entspricht in den Testbedingungen dem höchsten gemessenen Wert des Geräuschpegels.

■ The A-weighted sound power level, LpA (Chap.14), is the value measured in test conditions at the point of maximum noise level.

■ El nivel de presión sonora ponderado A, LpA (cap. 14), corresponde al valor medido, en las condiciones de prueba, en el punto con máximos niveles de ruido.

Tipo • Type • Type • Typ • Tipo		P inst. [kW]	n	LpA [dB(A)]	Tolleranza sulla portata ±5% • Tolérance sur le débit ±5% • Load tolerance ±5% • Durchsatztoleranz ±5% • Tolerancia respecto caudal ±5%														
Ventilatore • Ventilateur • Fan • Ventilator • Ventilador	Motore • Moteur • Motor • Motor • Motor				Q [m³/h]														
					1440	1620	1800	1980	2160	2520	2880	3240	3600	3960	4320	4680	5400	6120	
					pt[mmH ₂ O]														
PRA250/2R	90	2,2	2920	65	251	249	246	242	238	227	213								
PRA250/2	100	3	2930	66	260	258	255	252	248	239	227	213	194						
PRA280/2R	112	4	2930	69				331	327	318	308	297	283	269	253				
PRA280/2	132	5,5	2950	72				346	342	334	324	313	299	284	267	229			
PRA320/2R	132	7,5	2950	77							396	391	384	376	360	354	324	288	
PRA320/2	160	11	2950	80							433	430	426	420	412	403	379	350	
PRA360/2R	160	11	2950	76									476	471	465	459	444	429	
PRA360/2	160	15	2960	84										513	508	502	491	477	
PRA400/2R	180	22	2960	84												587	578	567	
PRA400/2	200	30	2970	87													646	638	
PRA450/2R	200	37	2970	87															
PRA450/2	225	45	2970	87															
PRA500/2R	280	75	2970	91															
PRA500/2	280	90	2970	94															
PRA560/2R	315	132	2980	92															
PRA560/2	315	160	2980	98															
PRA360/4R	90	1,5	1420	62				112	111	108	103	99	93	88	81	72			
PRA360/4	100	2,2	1420	63				122	120	118	114	111	105	100	95	88	72		
PRA400/4R	100	3	1420	65						140	137	135	131	127	123	118	108	94	
PRA400/4	112	4	1440	68							158	156	153	150	148	144	134	124	
PRA450/4R	112	4	1440	69									182	179	176	174	168	160	
PRA450/4	132	5,5	1455	70										209	208	206	201	196	
PRA500/4R	132	7,5	1455	69												248	246	241	
PRA500/4	160	11	1460	77													268	264	
PRA560/4R	160	15	1460	78															
PRA560/4	180	22	1470	81															
PRA630/4R	200	30	1470	82															
PRA630/4	225	37	1480	86															
PRA700/4R	225	45	1480	83															
PRA700/4	250	55	1480	87															
PRA800/4R	280	75	1480	89															
PRA800/4	315	110	1485	94															
PRA900/4R	315	132	1485	92															
PRA900/4	315	160	1485	95															
PRA560/6R	132	4	950	64												136	134	131	
PRA560/6	132	5,5	950	69													146	143	
PRA630/6R	160	7,5	960	71														169	
PRA630/6	160	11	960	73															
PRA700/6R	180	15	970	74															
PRA700/6	200	18,5	975	77															
PRA800/6R	200	22	975	79															
PRA800/6	225	30	975	81															
PRA900/6R	250	37	980	83															
PRA900/6	280	55	980	86															

Il livello di pressione sonora ponderato A, LpA (cap.14), corrisponde al valore rilevato, nelle condizioni di prova, nel punto di massima rumorosità.

Tolleranza sulla rumorosità ±4dB(A)

- Tolérance sur le bruit ±4dB(A) • Noise tolerance ±4dB(A)
- Geräuschtoleranz ±4dB(A) • Tolerancia respecto a ruido ±4dB(A)

Q [m³/h]																						
7200	7920	8640	9360	10800	12600	14400	16200	18000	19800	21600	25200	28800	32400	36000	39600	43200	46800	54000	61000	72000	79200	
pt[mmH ₂ O]																						
224																						
297	256	210																				
401	378	352																				
453	434	413	386	321	239																	
549	537	522	505	466	407	331																
624	614	603	589	558	513	457	386	303														
735	726	716	707	684	650	609	562	504	435													
	826	817	809	791	765	735	700	659	610	554												
				951	933	914	890	864	835	800	718	614										
				1031	1016	1000	978	957	933	907	837	756	660	545								
							1201	1188	1173	1157	1139	1098	1048	990	920							
								1272	1264	1256	1236	1202	1170	1111	1047	979	911	820				
104	89																					
148	138	123	110																			
185	175	168	157	134																		
234	228	222	215	198																		
258	254	249	244	231	212	188	159	125														
316	312	308	304	293	285	266	247	231	205													
	341	338	334	327	316	303	288	270	251	228	171											
			387	382	373	363	353	340	326	309	264	223										
				424	417	409	399	389	377	368	334	296	249	194								
						477	470	462	453	443	419	390	356	317								
							532	526	519	512	493	471	445	416	381	342	298					
										590	577	561	542	520	496	468	436	362				
											662	652	639	624	607	588	566	541	485	419	291	
													724	695	700	685	669	651	609	561	465	
														820	813	803	792	780	766	735	631	575
126	122	120	116	104																		
138	135	132	128	119	107	88																
165	163	161	159	152	142	133	117	99														
182	181	180	176	171	163	154	139	131	117	103												
		212	211	209	201	195	187	177	166	153	124											
			240	237	234	230	221	211	208	194	173	148	114									
					269	266	263	254	249	243	224	207	189	155								
						297	293	289	284	278	266	251	229	211	185	148	127					
							335	331	325	322	315	301	292	273	255	235	211					
									372	367	362	354	340	332	315	303	289	249	194			

■ Le niveau de pression sonore pondérée A, LpA (chap. 14), correspond à la valeur relevée dans les conditions d'essai au point de niveau sonore maximum.

■ Der nach A bewertete Schalldruckpegel LpA (Kap. 14) entspricht in den Testbedingungen dem höchsten gemessenen Wert des Geräuschpegels.

■ The A-weighted sound power level, LpA (Chap.14), is the value measured in test conditions at the point of maximum noise level.

■ El nivel de presión sonora ponderado A, LpA (cap. 14), corresponde al valor medido, en las condiciones de prueba, en el punto con máximos niveles de ruido.

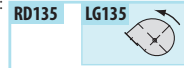
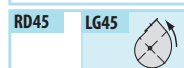
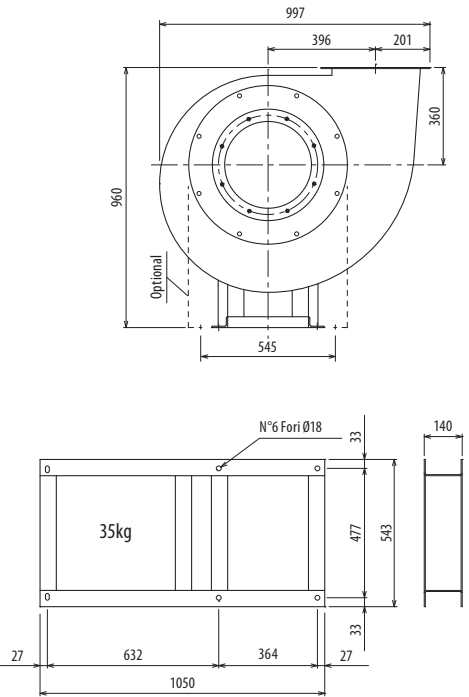
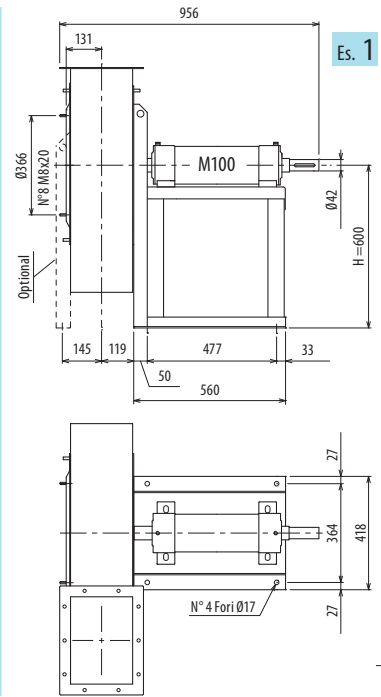
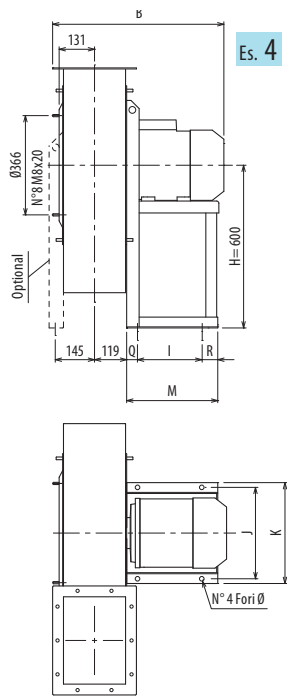

Il ventilatore è orientabile - Peso in tabella comprensivo di motore

- Le ventilateur est orientable
 - The fan is revolvable
 - Der Ventilator ist drehbar
 - El ventilador es orientable
- Le poids dans le tableau inclut le moteur The weight indicated in the table includes motor Das Gewicht im Tafel schließt den Motor ein El peso en la tabla incluye el motor

Ulteriori informazioni e quote:
 ■ Ulérieures informations et cotes:
 ■ Further information and sizes:
 ■ Weitere Infos und Größen:
 ■ Más informaciones y medidas:

TIPO - Type		PESO Weight	PD ²	B	I	H	H1	H2	J	K	M	Q	R	Ø
VENTILATORE Fan	MOTORE Motor	Kg	Kgf x m ²											
PRA320/2R	132 S2	145	1,8	640	237	600	360	600	337	372	345	44	64	12
PRA320/2	160 M2	210	2,0	780	337	600	360	600	395	440	446	55	54	14
PRA320/T		135	2,0			600	360	600						

pg. / S. 4,6

pg. / S. 4,5

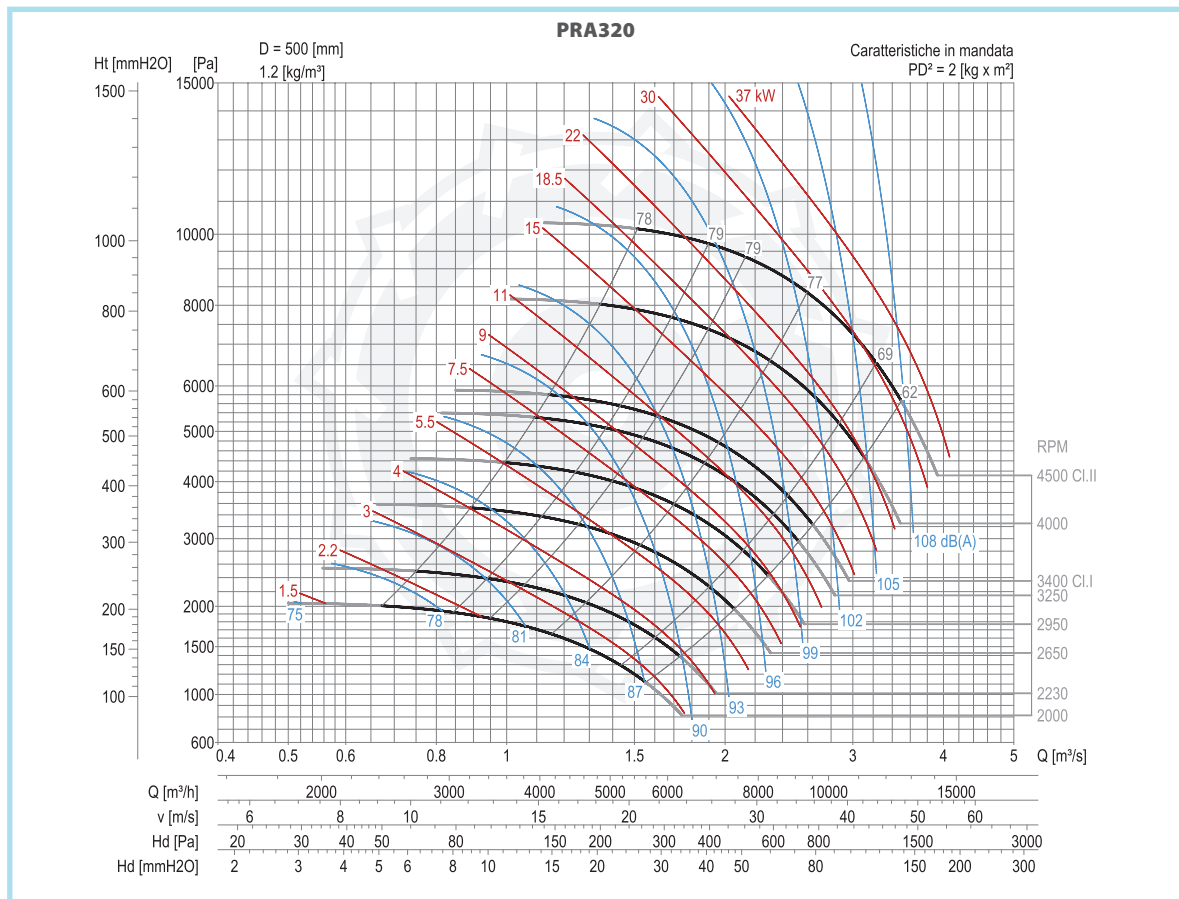
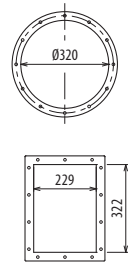

DIMENSIONI D'INGOMBRO E PESI/CURVE DI FUNZIONAMENTO

PRA360

■ DIMENSIONS D'ENCOMBREMENT ET POIDS/COURBES DE FONCTIONNEMENT ■ OVERALL DIMENSIONS AND WEIGHT/WORKING CURVES
 ■ AUSMAßE UND GEWICHTE/FUNKTIONSKURVEN ■ DIMENSIONES QUE OCUPA Y PESOS/CURVAS DE FUNCIONAMIENTO

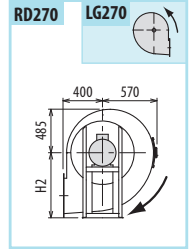
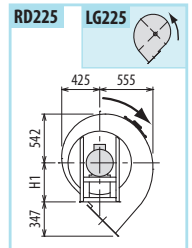
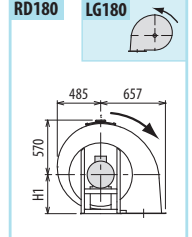
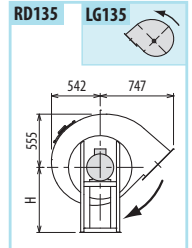
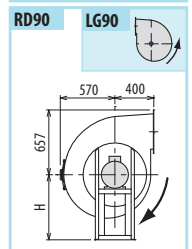
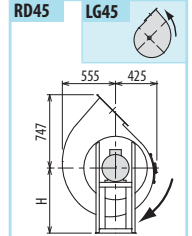
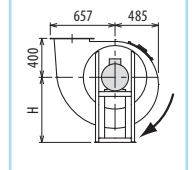
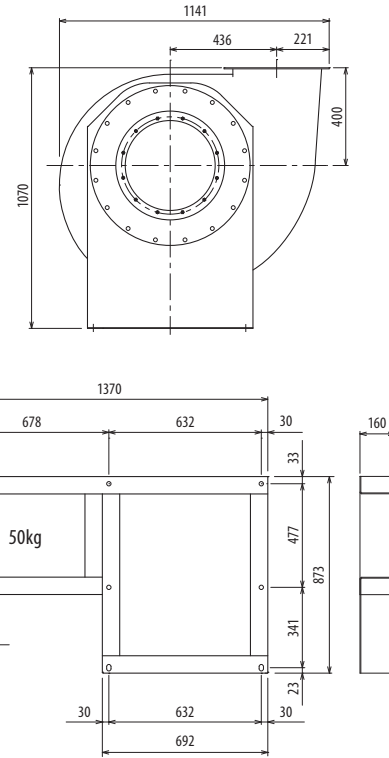
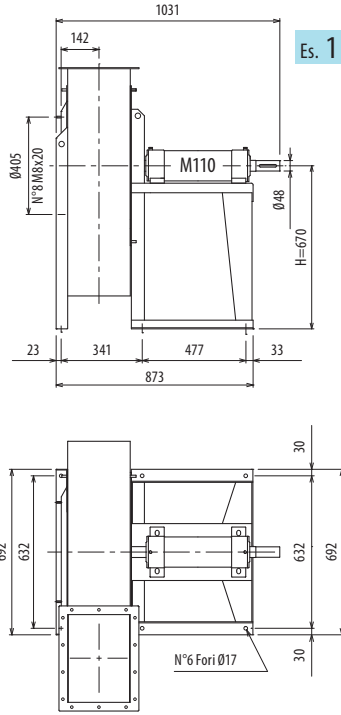
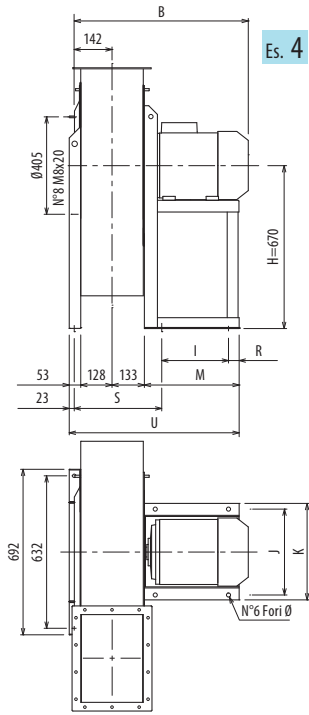

Il ventilatore è orientabile • Peso in tabella comprensivo di motore

■ Le ventilateur est orientable ■ The fan is revolvable ■ Der Ventilator ist drehbar ■ El ventilador es orientable
 Le poids dans le tableau inclut le moteur The weight indicated in the table includes motor Das Gewicht in Tafel schließt den Motor ein El peso en la tabla incluye el motor

Ulteriori informazioni e quote:
 ■ Ulérieures informations et cotes:
 ■ Further information and sizes:
 ■ Weitere Infos und Größen:
 ■ Más informaciones y medidas:

TIPO • Type		PESO Weight	PD ²	B	I	H	H1	H2	J	K	M	R	S	U	Ø
VENTILATORE Fan	MOTORE Motor	Kg	Kgf x m ²												
PRA360/2R	160 M2	227	2,3	792	337	670	400	670	395	440	446	54	340	754	14
PRA360/2	160 M2	240	2,4	792	337	670	400	670	395	440	446	54	340	754	14
PRA360/4R	90 L4	165	2,1	595	133	670	400	670	234	260	251	60	345	561	10
PRA360/4	100 L4	169	2,4	626	197	670	400	670	289	324	281	54	320	594	12
PRA360/T		187	2,5			670	400	670							

pg. / S. 4.6

pg. / S. 4.5

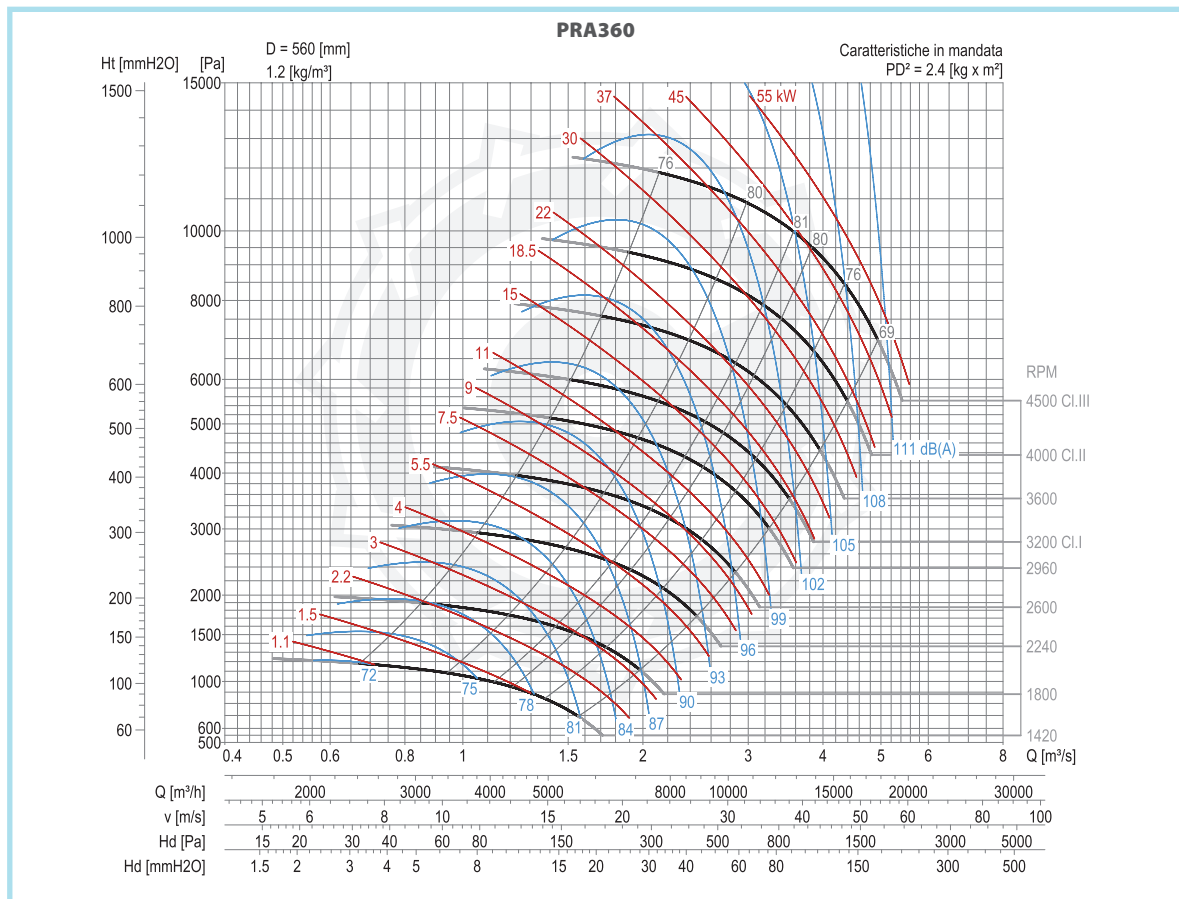
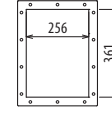
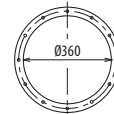

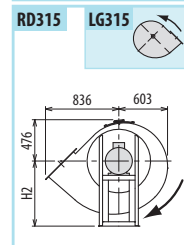
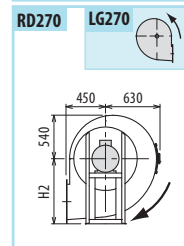
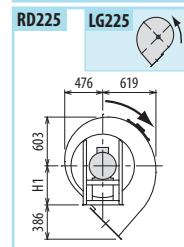
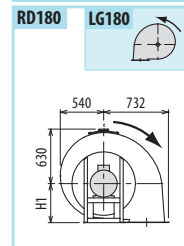
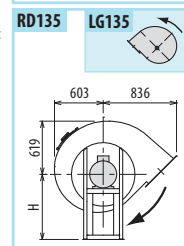
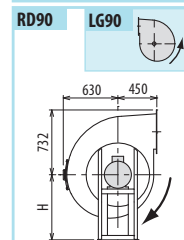
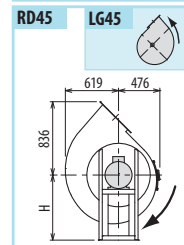
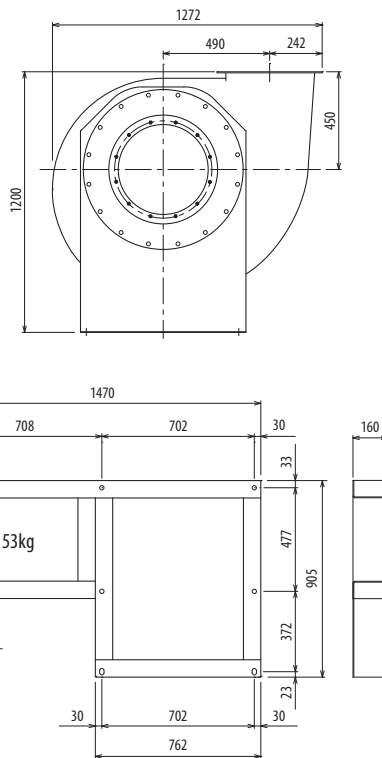
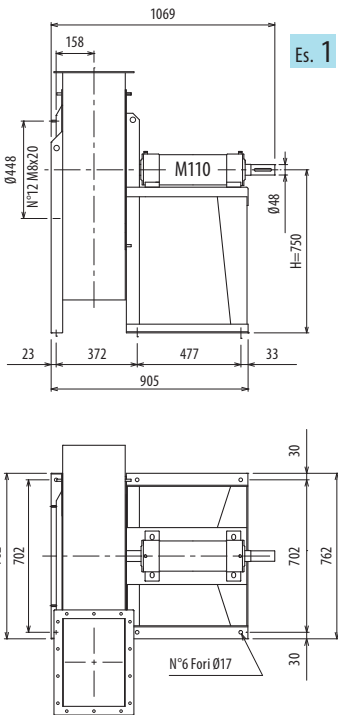
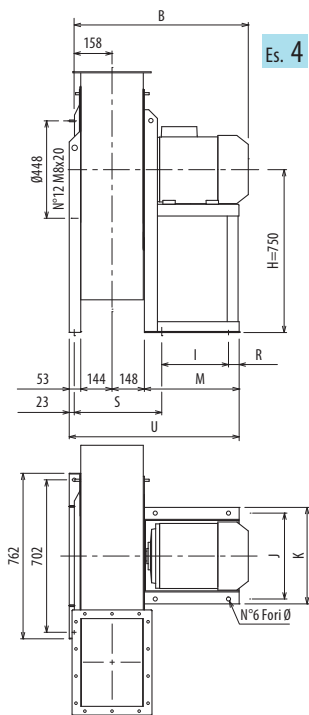

Il ventilatore è orientabile • Peso in tabella comprensivo di motore

- Le ventilateur est orientable
 - The fan is revolvable
 - Der Ventilator ist drehbar
 - El ventilador es orientable
- Le poids dans le tableau inclut le moteur The weight indicated in the table includes motor Das Gewicht in Tafel schließt den Motor ein El peso en la tabla incluye el motor

Ulteriori informazioni e quote:
 ■ Ulérieures informations et cotes:
 ■ Further information and sizes:
 ■ Weitere Infos und Größen:
 ■ Más informaciones y medidas:

TIPO • Type		PESO Weight	PD ²	B	I	H	H1	H2	J	K	M	R	S	U	Ø
VENTILATORE Fan	MOTORE Motor	Kg	Kgf x m ²												
PRA400/2R	180 M2	315	4	948	357	750	450	750	434	488	465	38	392	810	18
PRA400/2	200 L2	400	4,7	1012	381	750	450	750	506	568	509	48	402	854	20
PRA400/4R	100 L4	180	3,9	657	197	750	450	750	289	324	281	54	352	626	12
PRA400/4	112 M4	190	4,2	678	197	750	450	750	289	324	281	54	352	626	12
PRA400/T		218	5,0			750	450	750							

pg. / s. 4,6

pg. / s. 4,5

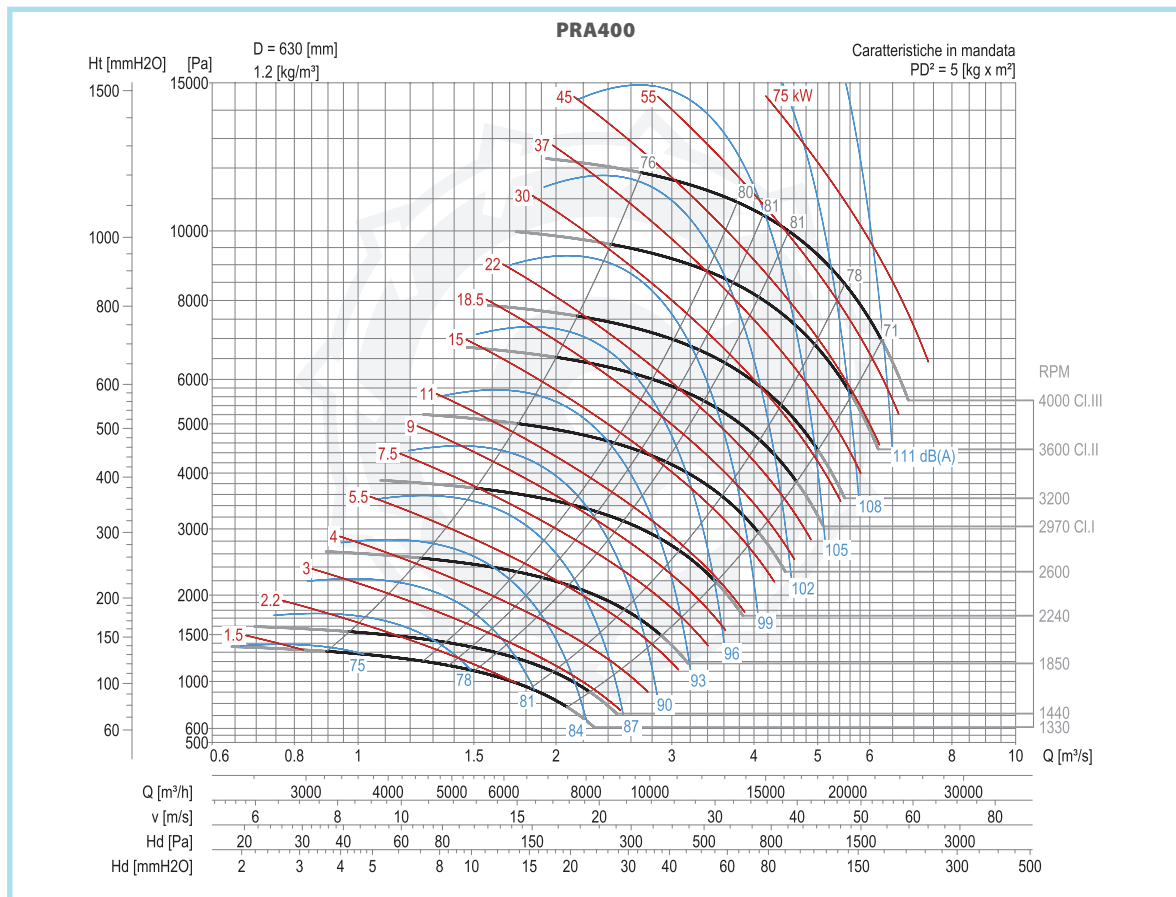
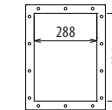
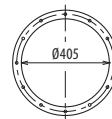

■ DIMENSIONS D'ENCOMBREMENT ET POIDS/COURBES DE FONCTIONNEMENT ■ OVERALL DIMENSIONS AND WEIGHT/WORKING CURVES
 ■ AUSMAßE UND GEWICHTE/FUNKTIONSKURVEN ■ DIMENSIONES QUE OCUPA Y PESOS/CURVAS DE FUNCIONAMIENTO

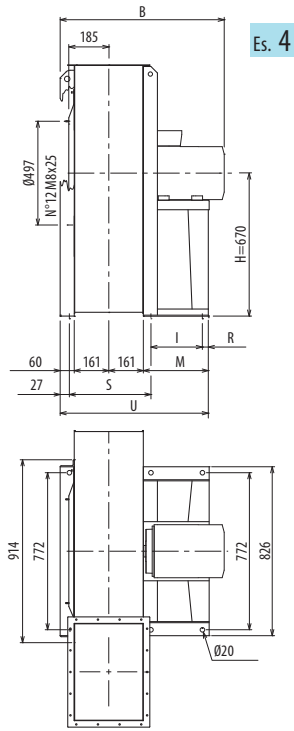

Es. 4

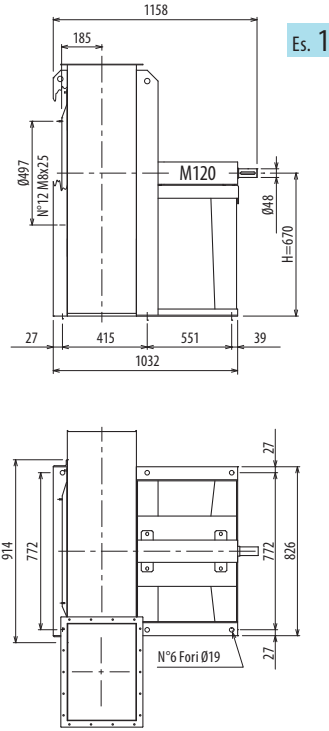

Es. 1

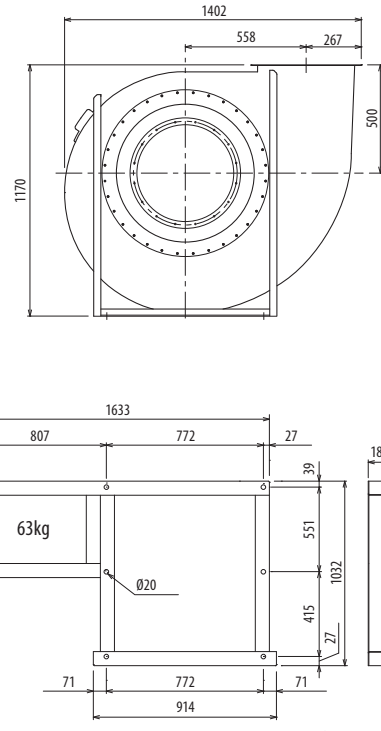

Il ventilatore non è orientabile • Peso in tabella comprensivo di motore

- Le ventilateur n'est pas orientable
- The fan is not revolvable
- Der Ventilator ist nicht drehbar
- El ventilador no es orientable
- Le poids dans le tableau inclut le moteur
- The weight indicated in the table includes motor
- Das Gewicht in Tafel schließt den Motor ein
- El peso en la tabla incluye el motor

Ulteriori informazioni e quote:
 ■ Ulérieures informations et cotes:
 ■ Further information and sizes:
 ■ Weitere Infos und Größen:
 ■ Más informaciones y medidas:

TIPO • Type		PESO Weight	PD ²	B	I	H	H1	H2	R	S	M	U
VENTILATORE Fan	MOTORE Motor	Kg	Kgf x m ²									
PRA450/2R	200 L2	492	10	1049	401	670	500	850	39	415	500	882
PRA450/2	225 M2	602	11	1091	441	670	500	850	39	415	540	922
PRA450/4R	112 M4	249	9	715	151	670	500	850	65	415	277	658
PRA450/4	132 S4	272	10	755	201	670	500	850	76	415	337	719
PRA450/T		336	10			670	500	850				

pg. / S. 4,6
 pg. / S. 4,5

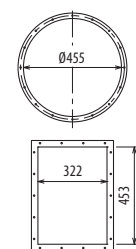

RD0 LG0

RD45 LG45

RD90 LG90

RD135 LG135

RD180 LG180

RD225 LG225

RD270 LG270

RD315 LG315

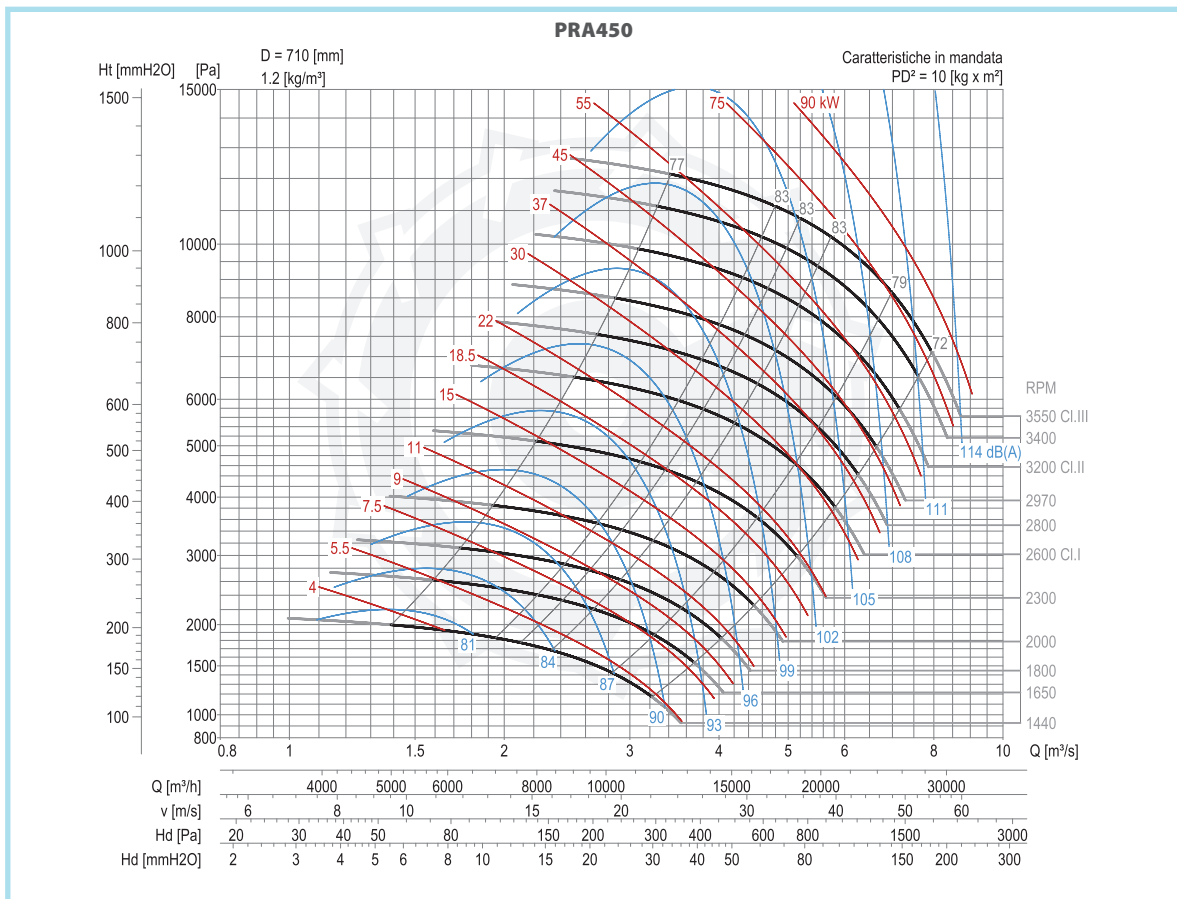

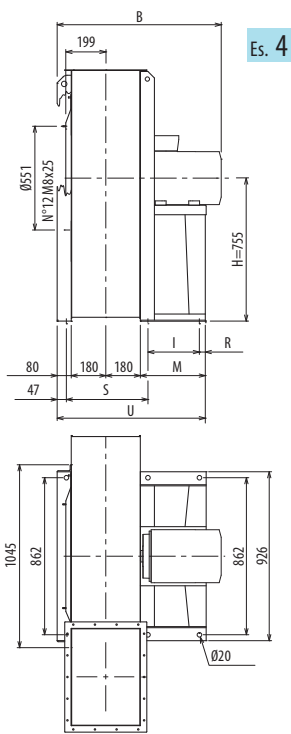

Es. 4

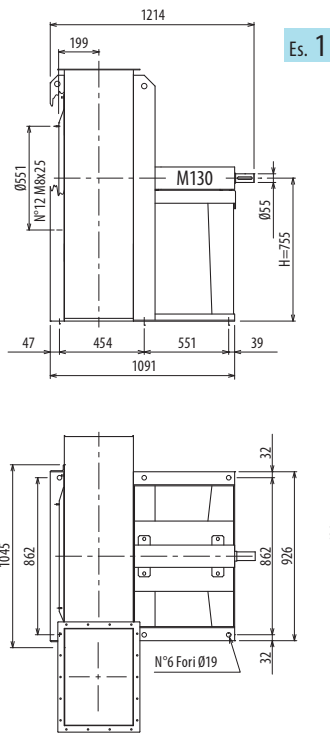

Es. 1

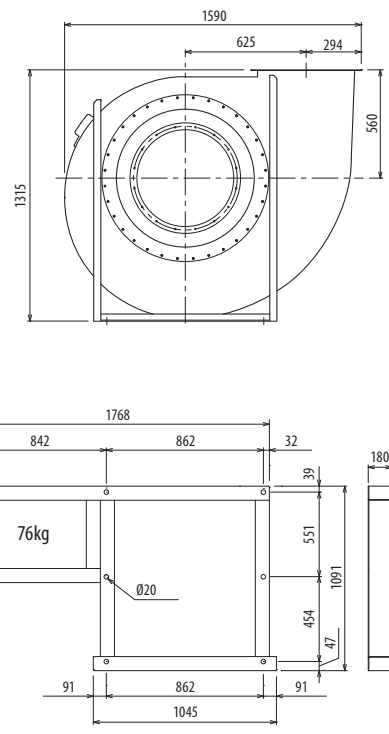

Il ventilatore non è orientabile • Peso in tabella comprensivo di motore

- Le ventilateur n'est pas orientable
 - The fan is not revolvable
 - Der Ventilator ist nicht drehbar
 - El ventilador no es orientable
- Le poids dans le tableau inclut le moteur The weight indicated in the table includes motor Das Gewicht im Tafel schließt den Motor ein El peso en la tabla incluye el motor

Ulteriori informazioni e quote:
 ■ Ulérieures informations et cotes:
 ■ Further information and sizes:
 ■ Weitere Infos und Größen:
 ■ Más informaciones y medidas:

TIPO • Type		PESO Weight	PD ²											
VENTILATORE Fan	MOTORE Motor	Kg	Kgf x m ²	B	I	H	H1	H2	R	S	M	U		
PRA500/2R	280 S2	800	15	1370	591	755	560	950	39	454	690	1131		
PRA500/2	280 M2	860	17	1370	591	755	560	950	39	454	690	1131		
PRA500/4R	132 M4	370	14	813	201	755	560	950	75	454	336	777		
PRA500/4	160 M4	415	16	918	316	755	560	950	60	454	436	877		
PRA500/T		400	18			755	560	950						

pg. / s. 4,6
 pg. / s. 4,5

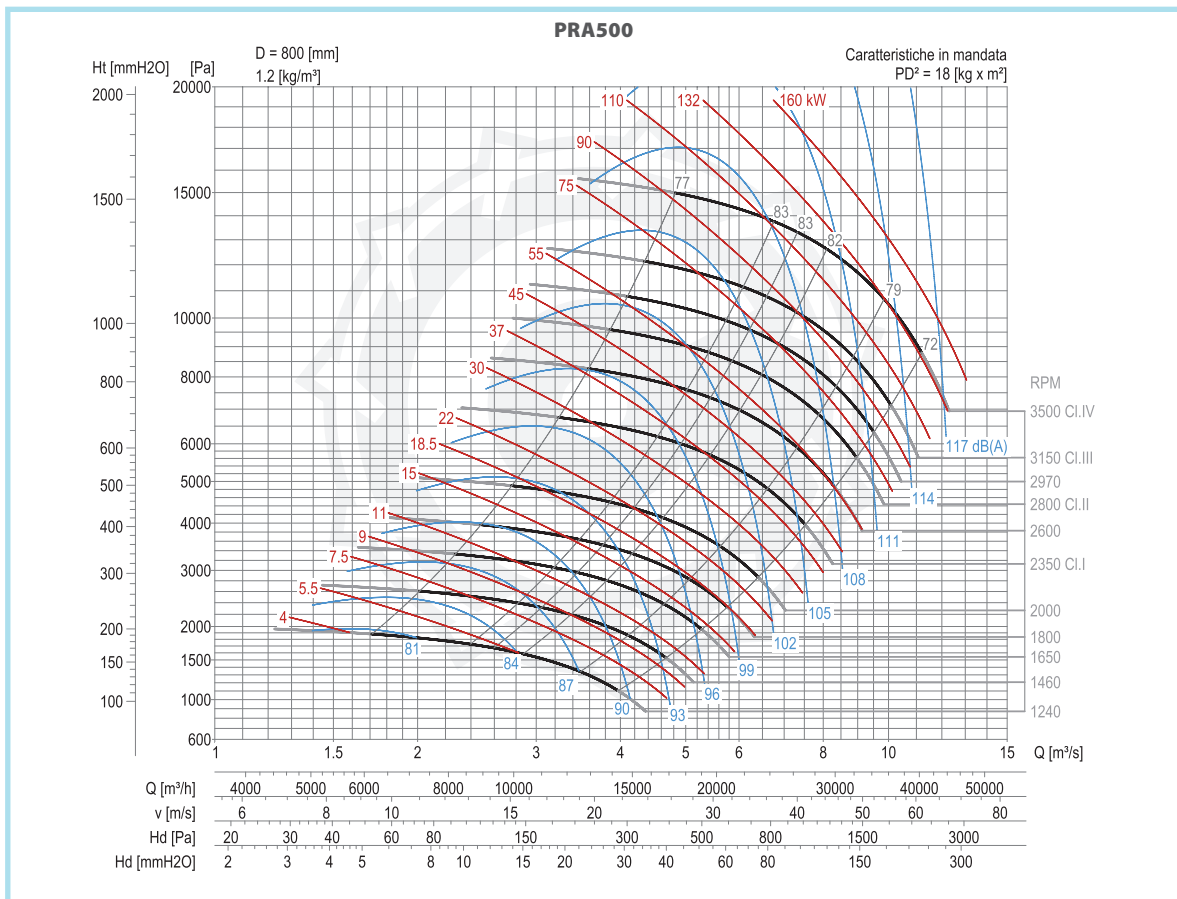
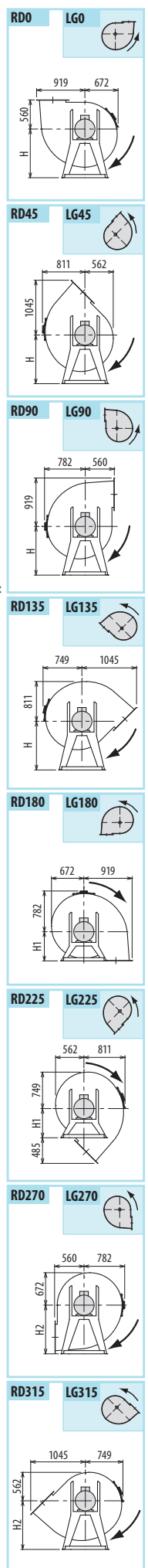
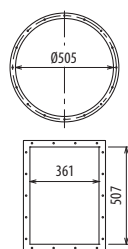

■ DIMENSIONS D'ENCOMBREMENT ET POIDS/COURBES DE FONCTIONNEMENT ■ OVERALL DIMENSIONS AND WEIGHT/WORKING CURVES
 ■ AUSMAßE UND GEWICHTE/FUNKTIONSKURVEN ■ DIMENSIONES QUE OCUPA Y PESOS/CURVAS DE FUNCIONAMIENTO

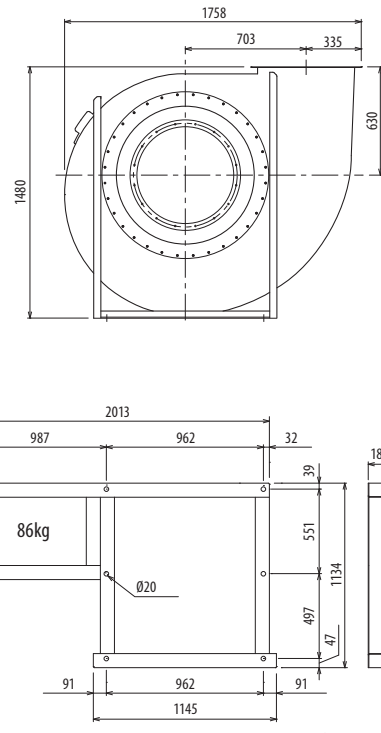
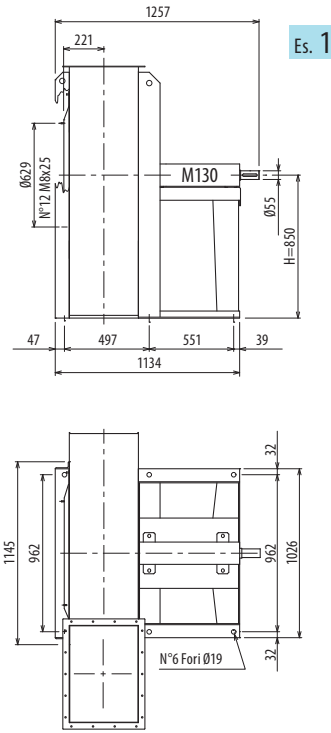
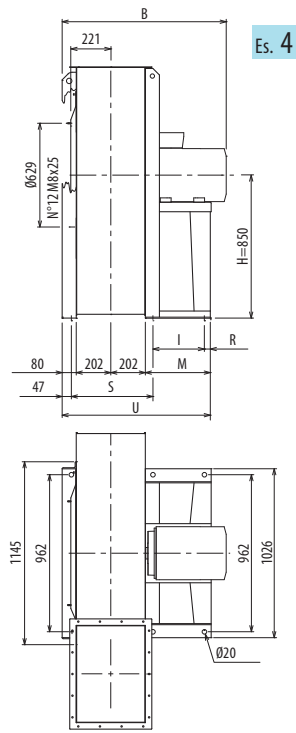

Il ventilatore non è orientabile • Peso in tabella comprensivo di motore

■ Le ventilateur n'est pas orientable ■ The fan is not revolvable ■ Der Ventilator ist nicht drehbar ■ El ventilador no es orientable
 Le poids dans le tableau inclut le moteur The weight indicated in the table includes motor Das Gewicht im Tafel schließt den Motor ein El peso en la tabla incluye el motor

Ulteriori informazioni e quote:
 ■ Ulérieures informations et cotes:
 ■ Further information and sizes:
 ■ Weitere Infos und Größen:
 ■ Más informaciones y medidas:

TIPO • Type		PESO Weight	PD ²	B	I	H	H1	H2	R	S	M	U
VENTILATORE Fan	MOTORE Motor	Kg	Kgf x m ²									
PRA560/2R	315 M2	1065	26	1516	675	850	630	1060	39	497	800	1258
PRA560/2	315 M2	1090	29	1516	675	850	630	1060	39	497	800	1258
PRA560/4R	160 L4	495	25	962	316	850	630	1060	60	497	436	920
PRA560/4	180 L4	576	28	1094	361	850	630	1060	39	497	460	944
PRA560/6R	132 M6	441	24	857	201	850	630	1060	75	497	336	820
PRA560/6	132 M6	450	27	857	201	850	630	1060	75	497	336	820
PRA560/T		489	29		850	630	1060					

pg. / s. 4,6
 pg. / s. 4,5

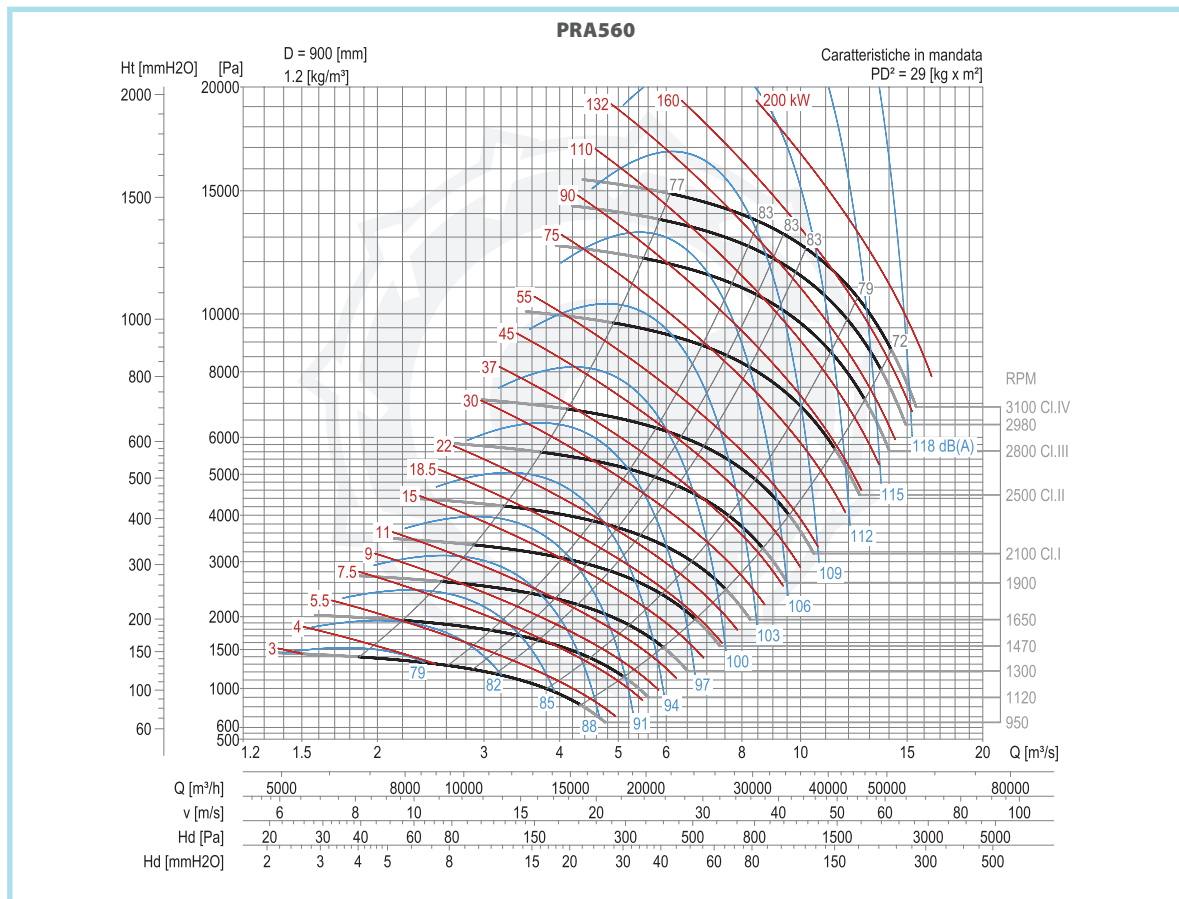
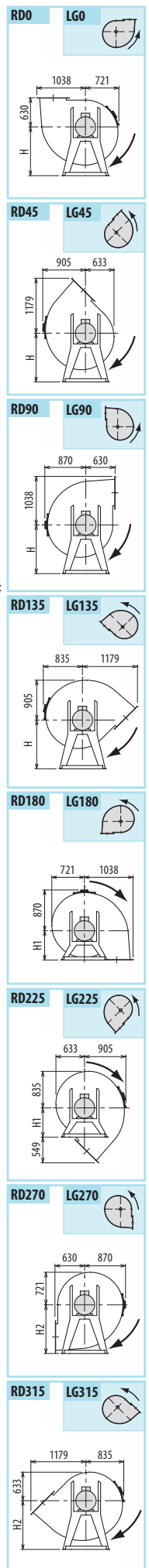
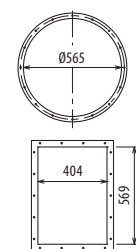

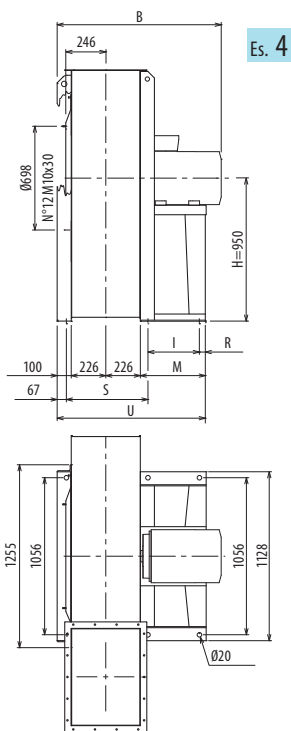

Es. 4

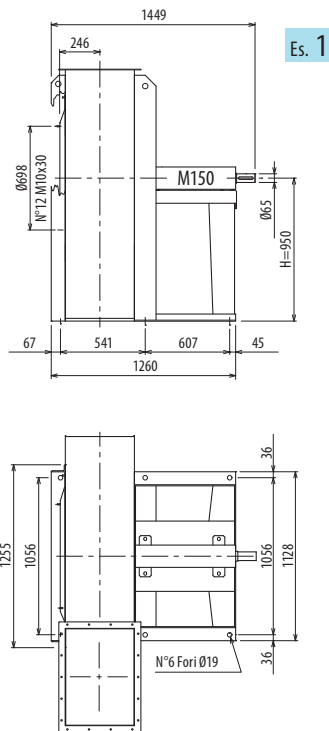

Es. 1

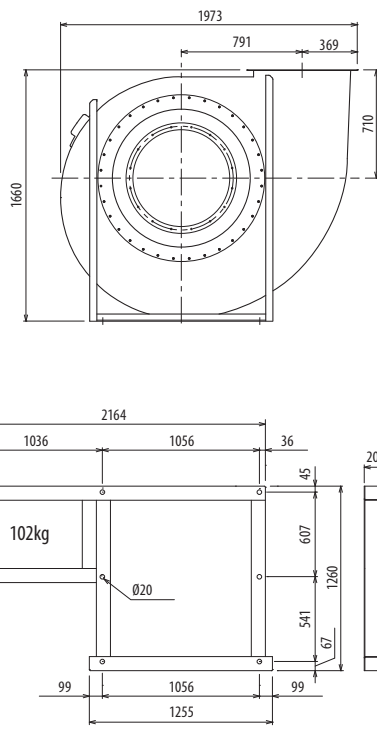

Il ventilatore non è orientabile • Peso in tabella comprensivo di motore

- Le ventilateur n'est pas orientable
 - The fan is not revolvable
 - Der Ventilator ist nicht drehbar
 - El ventilador no es orientable
- Le poids dans le tableau inclut le moteur The weight indicated in the table includes motor Das Gewicht im Tafel schließt den Motor ein El peso en la tabla incluye el motor

Ulteriori informazioni e quote:
 ■ Ulérieures informations et cotes:
 ■ Further information and sizes:
 ■ Weitere Infos und Größen:
 ■ Más informaciones y medidas:

TIPO • Type		PESO Weight	PD ²	B	I	H	H1	H2	R	S	M	U
VENTILATORE Fan	MOTORE Motor	Kg	Kgf x m ²									
PRA630/4R	200 L4	794	47	1219	400	950	710	1180	45	541	500	1053
PRA630/4	225 S4	893	52	1252	440	950	710	1180	45	541	540	1093
PRA630/6R	160 M6	613	46	1030	315	950	710	1180	66	541	436	989
PRA630/6	160 L6	626	51	1030	315	950	710	1180	66	541	436	989
PRA630/T		694	52			950	710	1180				

pg. / S. 4,6
 pg. / S. 4,5

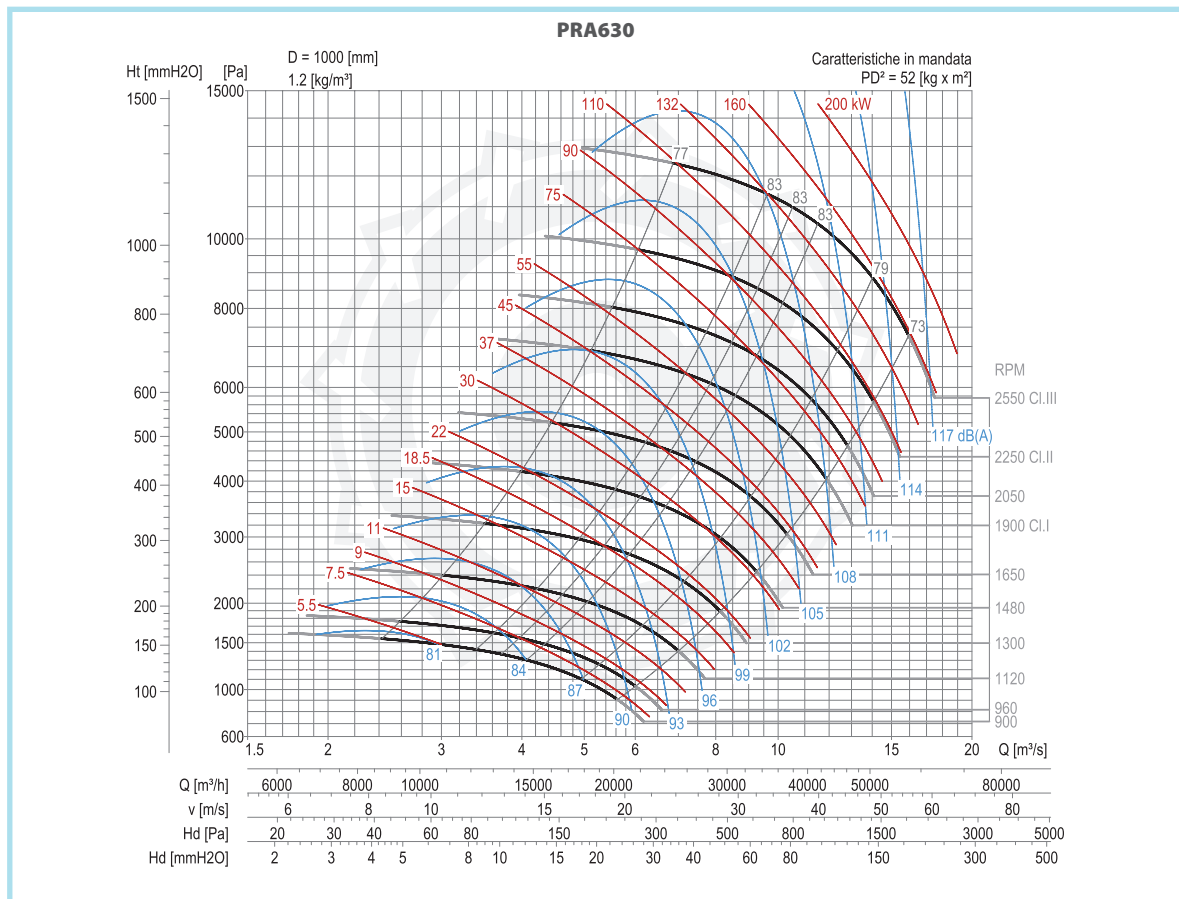
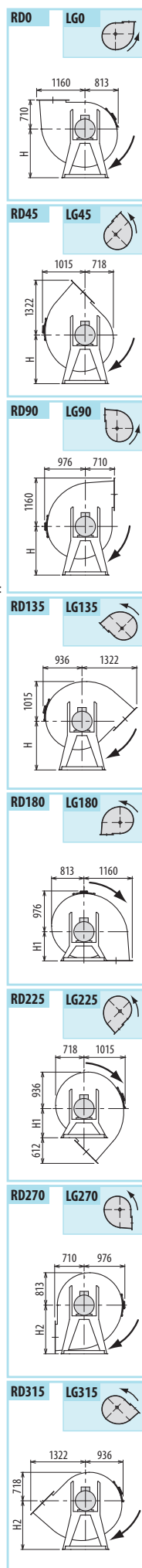
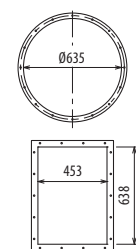

DIMENSIONI D'INGOMBRO E PESI/CURVE DI FUNZIONAMENTO

PRA700

■ DIMENSIONS D'ENCOMBREMENT ET POIDS/COURBES DE FONCTIONNEMENT ■ OVERALL DIMENSIONS AND WEIGHT/WORKING CURVES
 ■ AUSMAßE UND GEWICHTE/FUNKTIONSKURVEN ■ DIMENSIONES QUE OCUPA Y PESOS/CURVAS DE FUNCIONAMIENTO

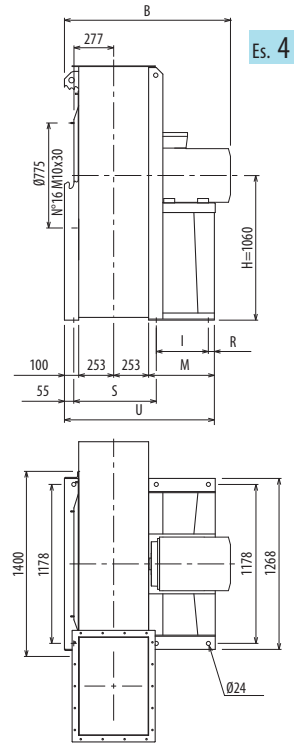

Es. 4

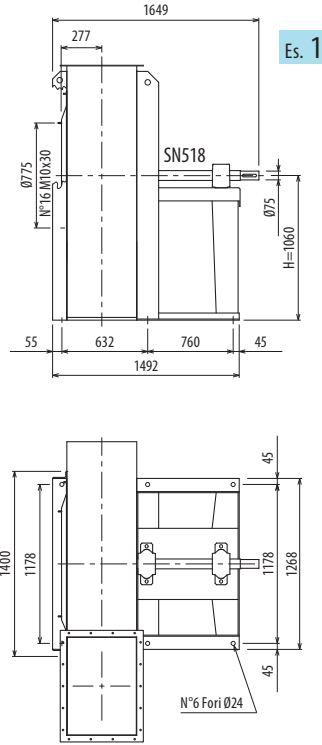

Es. 1

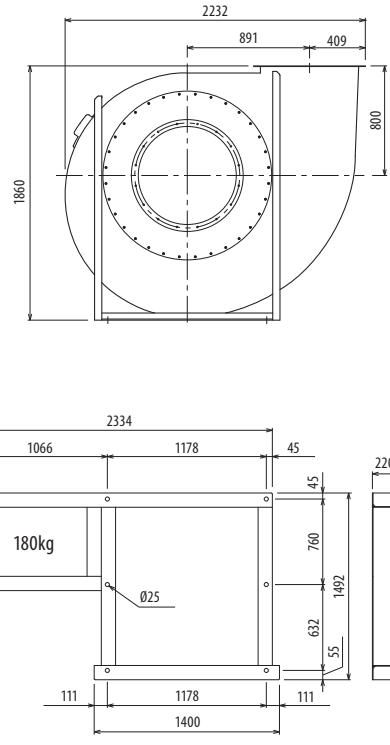

Il ventilatore non è orientabile • Peso in tabella comprensivo di motore

■ Le ventilateur n'est pas orientable ■ The fan is not revolvable ■ Der Ventilator ist nicht drehbar ■ El ventilador no es orientable
 Le poids dans le tableau inclut le moteur The weight indicated in the table includes motor Gewichtsgabangabe in Tabelle inkl. Motor El peso en la tabla incluye el motor

Ulteriori informazioni e quote:
 ■ Ulterérieures informations et cotes:
 ■ Further information and sizes:
 ■ Weitere Infos und Größen:
 ■ Más informaciones y medidas:

TIPO • Type		PESO Weight	PD ²											
VENTILATORE Fan	MOTORE Motor	Kg	Kgf x m ²	B	I	H	H1	H2	R	S	M	U		
PRA700/4R	225 M4	1032	90	1315	415	1060	800	1320	45	632	540	1147		
PRA700/4	250 M4	1132	97	1423	475	1060	800	1320	45	632	600	1207		
PRA700/6R	180 L6	836	88	1216	335	1060	800	1320	45	632	460	1067		
PRA700/6	200 L6	861	96	1273	375	1060	800	1320	45	632	500	1107		
PRA700/T		945	98			1060	800	1320						

pg./s. 4,6

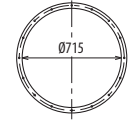

pg./s. 4,5

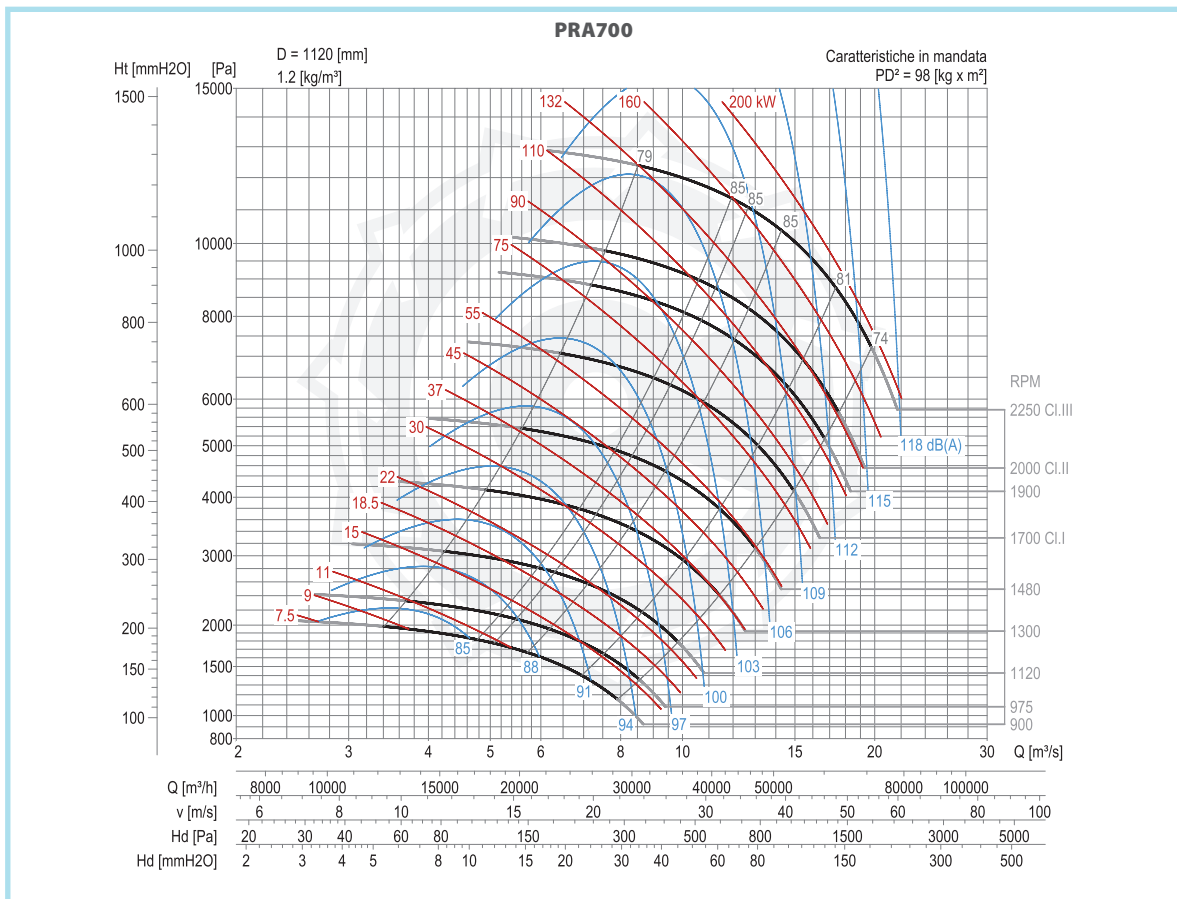
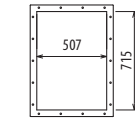

RD0 LG0

RD45 LG45

RD90 LG90

RD135 LG135

RD180 LG180

RD225 LG225

RD270 LG270

RD315 LG315

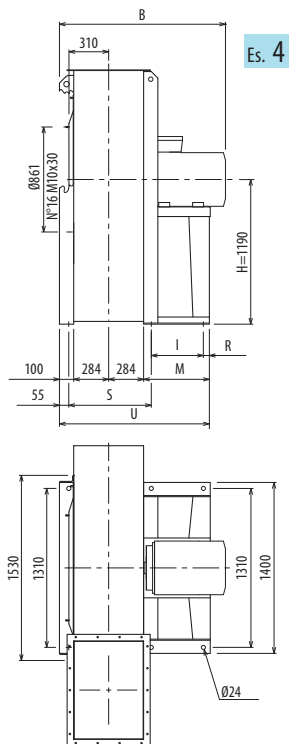

Es. 4

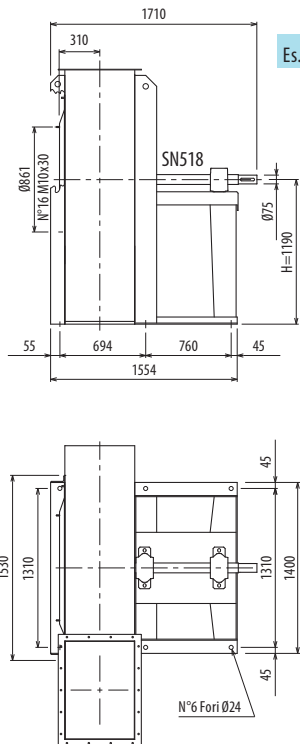

Es. 1

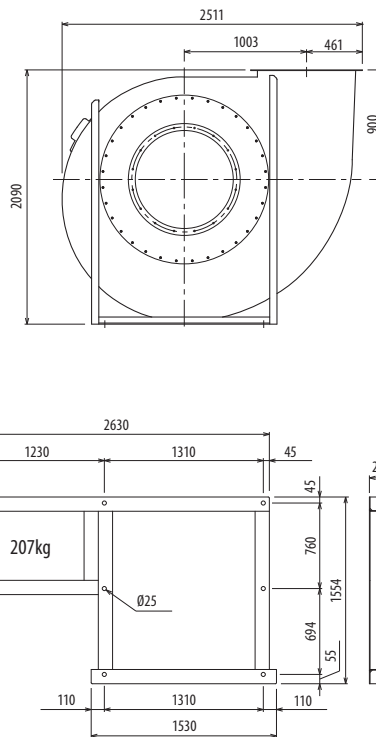

Il ventilatore non è orientabile • Peso in tabella comprensivo di motore

- Le ventilateur n'est pas orientable
 - The fan is not revolvable
 - Der Ventilator ist nicht drehbar
 - El ventilador no es orientable
- Le poids dans le tableau inclut le moteur The weight indicated in the table includes motor Gewichtsangabe in Tabelle inkl. Motor El peso en la tabla incluye el motor

Ulteriori informazioni e quote:
 ■ Ulteriori informazioni e cotes:
 ■ Further information and sizes:
 ■ Weitere Infos und Größen:
 ■ Más informaciones y medidas:

TIPO • Type		PESO Weight	PD ²											
VENTILATORE Fan	MOTORE Motor	Kg	Kgf x m ²	B	I	H	H1	H2	R	S	M	U		
PRA800/4R	280 S4	1442	154	1488	565	1190	900	1500	45	694	690	1359		
PRA800/4	315 S4	1770	172	1700	675	1190	900	1500	45	694	800	1469		
PRA800/6R	200 L6	900	152	1335	375	1190	900	1500	45	694	500	1169		
PRA800/6	225 M6	1287	170	1377	415	1190	900	1500	45	694	540	1209		
PRA800/T		1147	174			1190	900	1500						

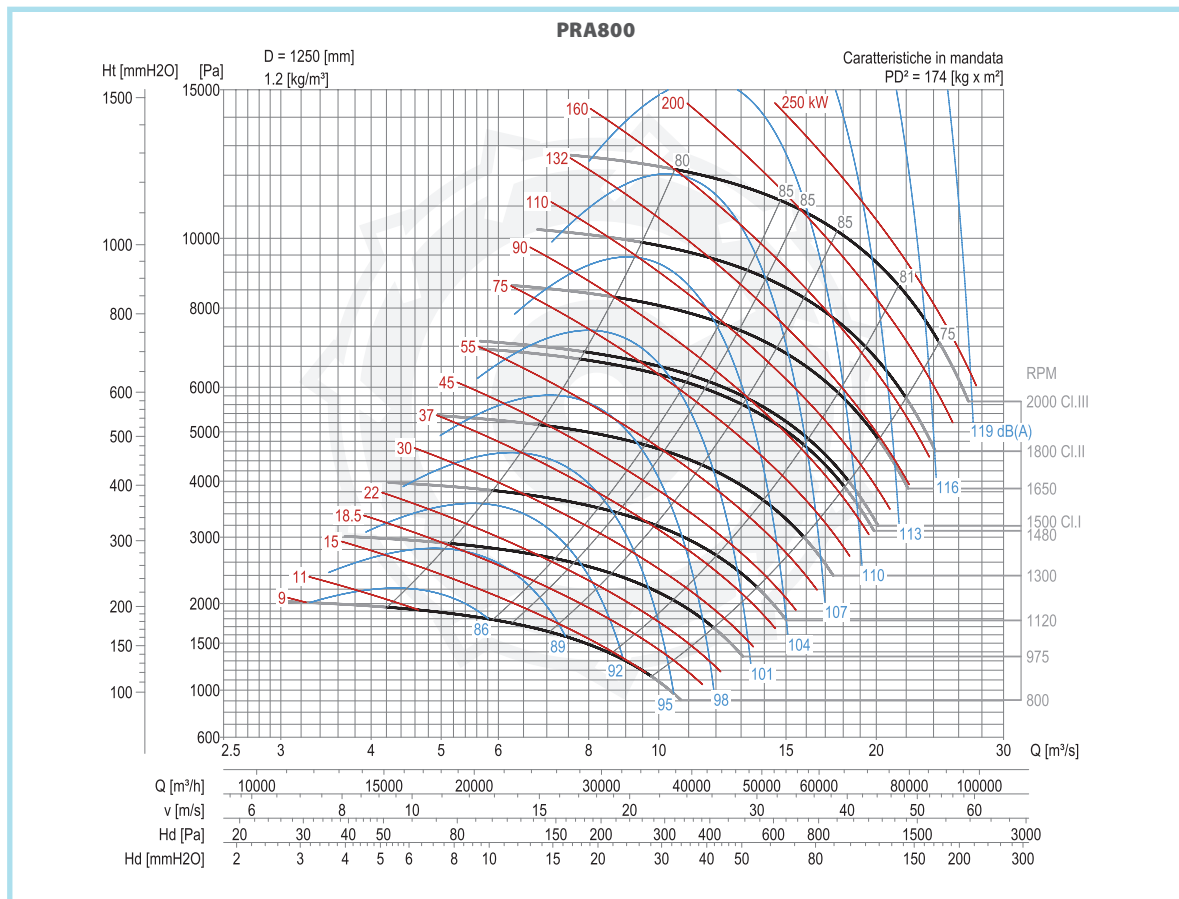
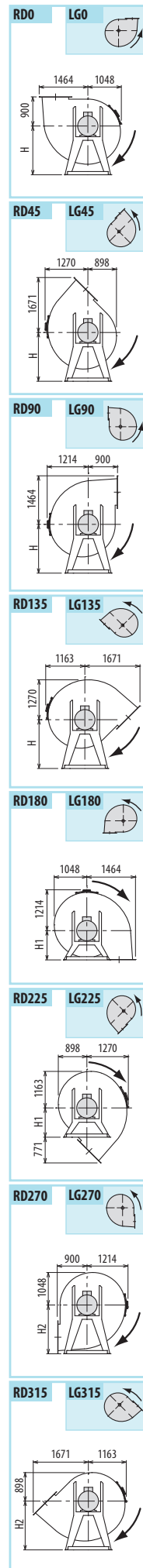
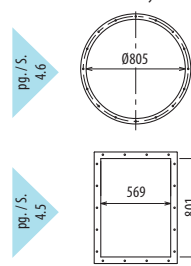

DIMENSIONI D'INGOMBRO E PESI/CURVE DI FUNZIONAMENTO

PRA900

■ DIMENSIONS D'ENCOMBREMENT ET POIDS/COURBES DE FONCTIONNEMENT ■ OVERALL DIMENSIONS AND WEIGHT/WORKING CURVES
 ■ AUSMAßE UND GEWICHTE/FUNKTIONSKURVEN ■ DIMENSIONES QUE OCUPA Y PESOS/CURVAS DE FUNCIONAMIENTO

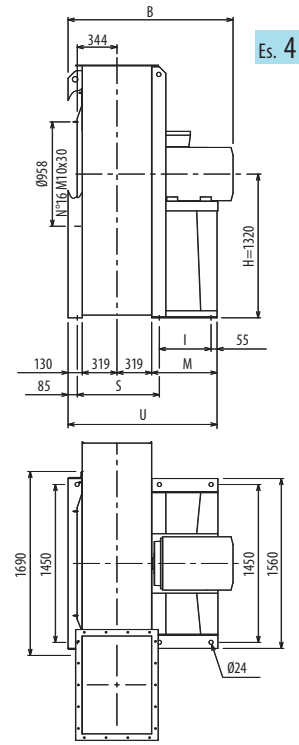

Es. 4

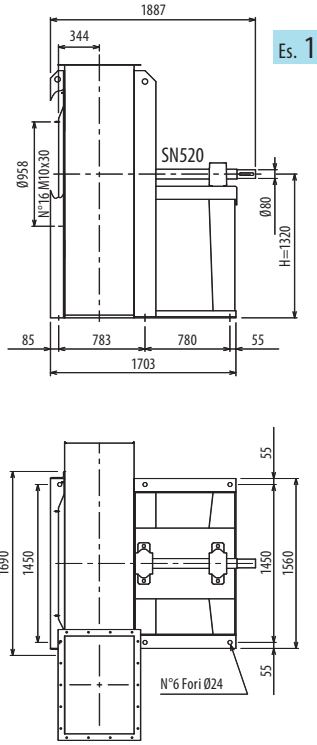

Es. 1

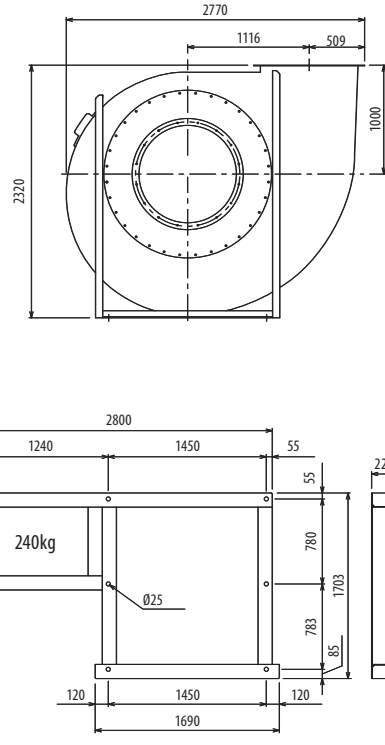

Il ventilatore non è orientabile • Peso in tabella comprensivo di motore

■ Le ventilateur n'est pas orientable ■ The fan is not revolvable ■ Der Ventilator ist nicht drehbar ■ El ventilador no es orientable
 Le poids dans le tableau inclut le moteur The weight indicated in the table includes motor Das Gewicht im Tafel schließt den Motor ein El peso en la tabla incluye el motor

Ulteriori informazioni e quote:
 ■ Ulérieures informations et cotes:
 ■ Further information and sizes:
 ■ Weitere Infos und Größen:
 ■ Más informaciones y medidas:

TIPO - Type		PESO Weight	PD ²	B	I	H	H1	H2	H3	H4	M	S	U
VENTILATORE Fan	MOTORE Motor	Kg	Kgf x m ²										
PRA900/4R	315 M4	2340	242	1890	645	1320	1000	1700	1320	1700	800	783	1568
PRA900/4	315 M4	2345	264	1890	645	1320	1000	1700	1320	1700	800	783	1568
PRA900/6R	250 M6	1819	241	1585	475	1320	1000	1700	1320	1700	600	753	1368
PRA900/6	280 M6	2058	262	1600	535	1320	1000	1700	1320	1700	690	783	1458
PRA900/T		1628	266			1320	1000	1700	1120	1500			

pg./S. 4,6
 pg./S. 4,5

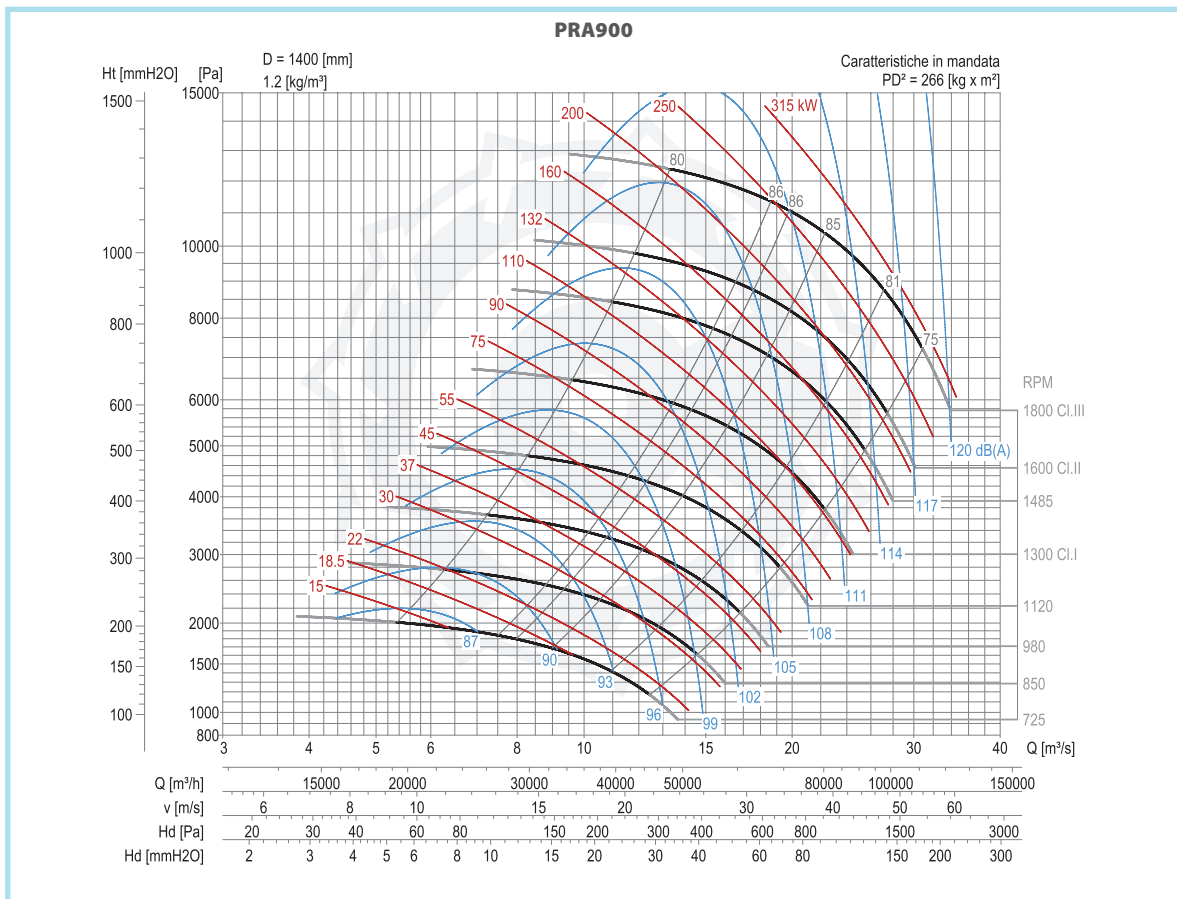
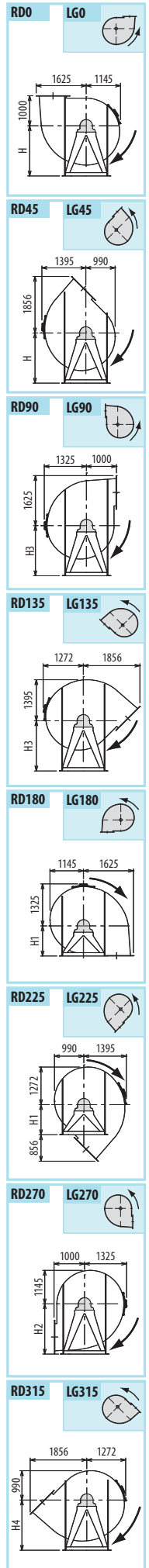
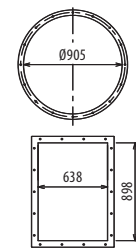

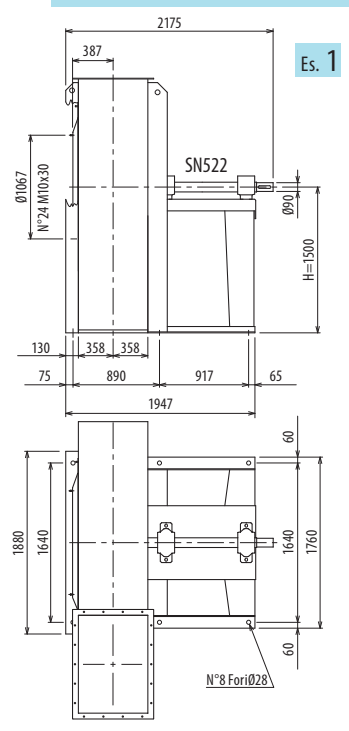

Es. 1

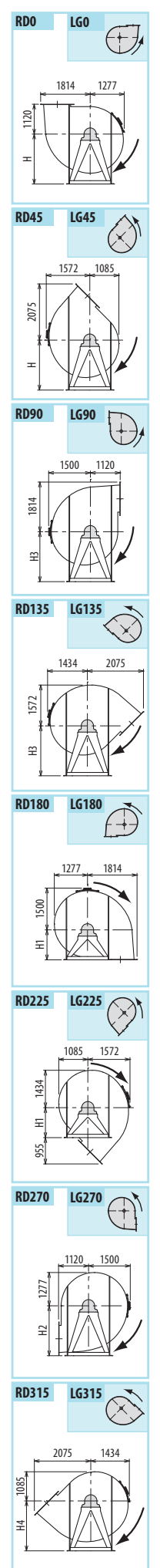
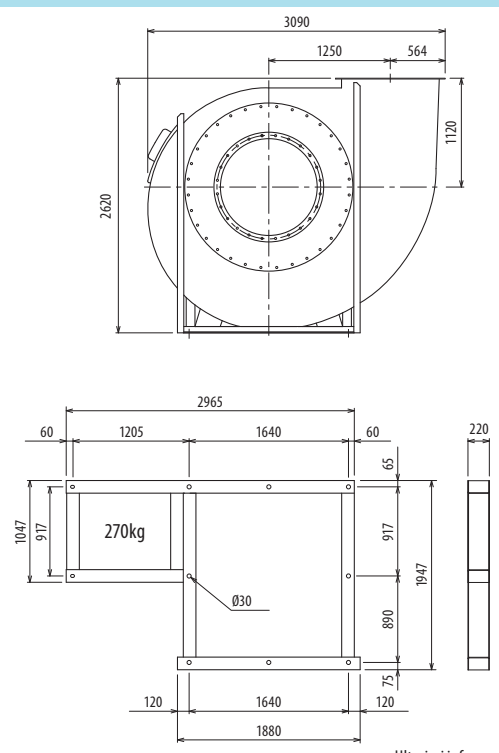

Il ventilatore non è orientabile

- Le ventilateur n'est pas orientable
- The fan is not revolvable
- Der Ventilator ist nicht drehbar
- El ventilador no es orientable

TIPO - Type		PESO Weight	PD ²							
VENTILATORE Fan	MOTORE Motor	Kg	Kgf x m ²	B	I	H	H1	H2	H3	H4
PRA1000/T		1888	473			1500	1120	1900	1250	1600

Ulteriori informazioni e quote:
 ■ Ulérieures informations et cotes:
 ■ Further information and sizes:
 ■ Weitere Infos und Größen:
 ■ Más informaciones y medidas:

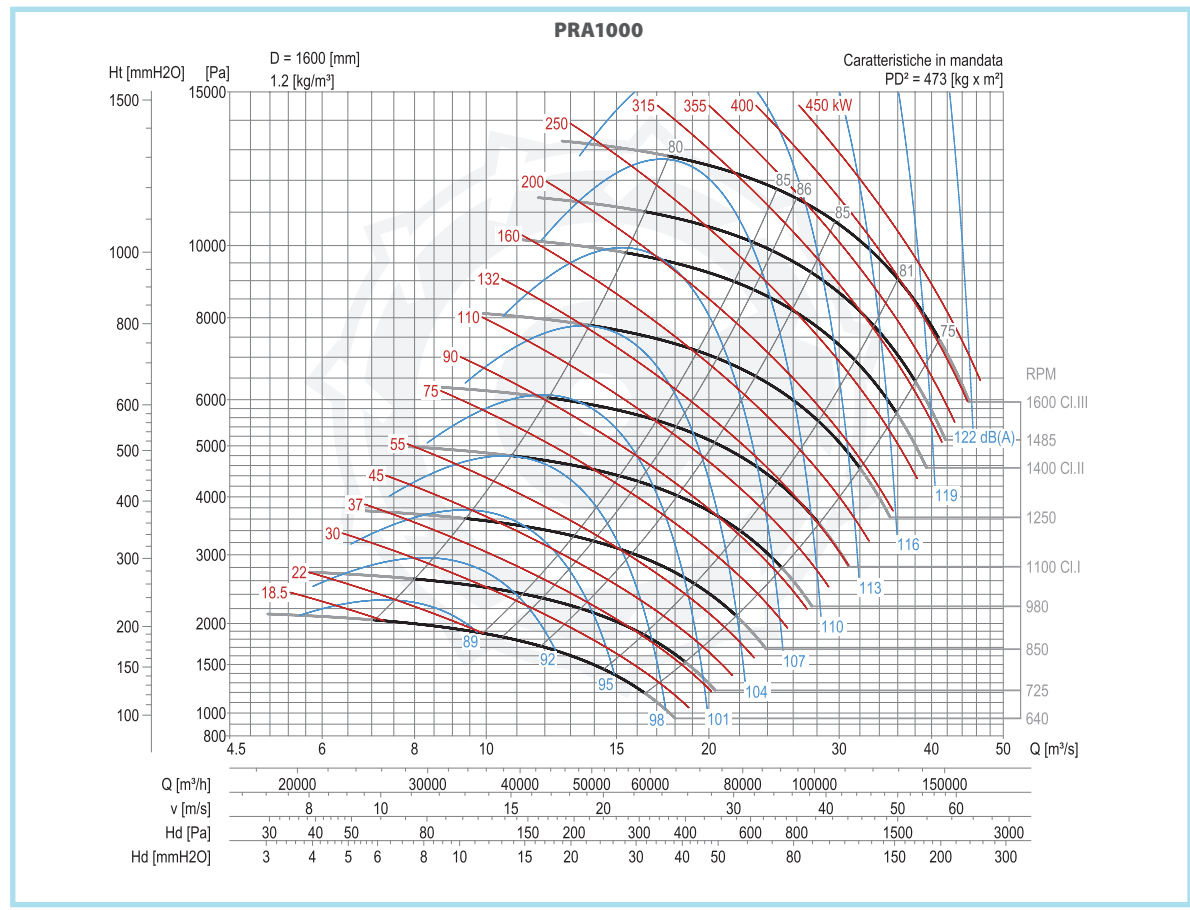
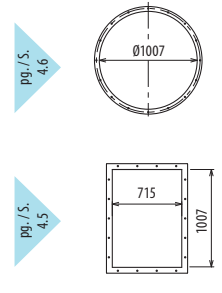

■ DIMENSIONS D'ENCOMBREMENT ET POIDS/COURBES DE FONCTIONNEMENT ■ OVERALL DIMENSIONS AND WEIGHT/WORKING CURVES
 ■ AUSMAßE UND GEWICHTE/FUNKTIONSKURVEN ■ DIMENSIONES QUE OCUPA Y PESOS/CURVAS DE FUNCIONAMIENTO

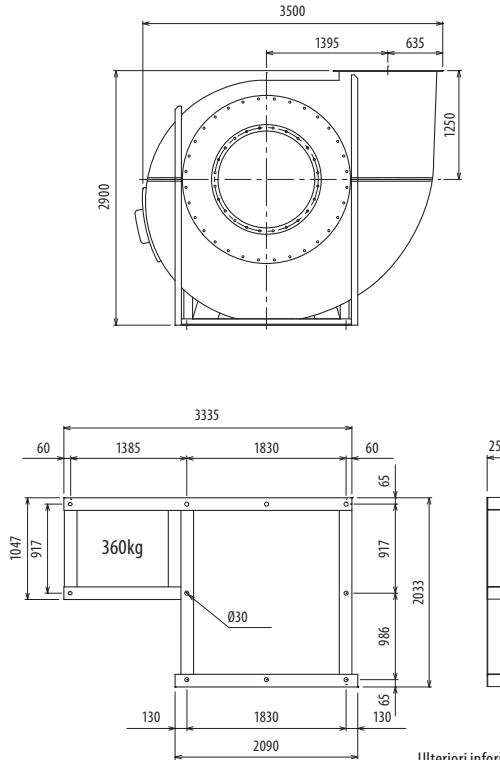
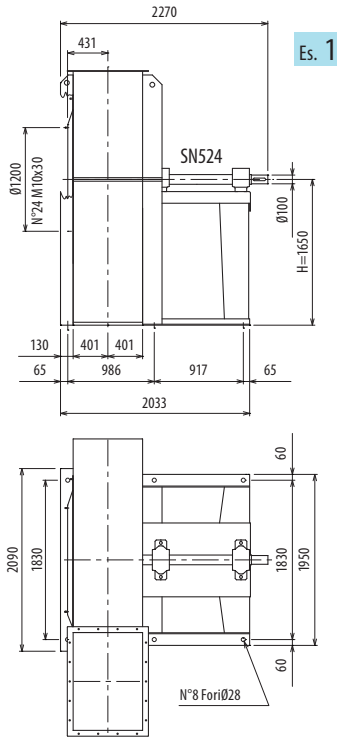

Il ventilatore non è orientabile

■ Le ventilateur n'est pas orientable

■ The fan is not revolvable

■ Der Ventilator ist nicht drehbar

■ El ventilador no es orientable

TIPO - Type		PESO Weight	PD ²											
VENTILATORE Fan	MOTORE Motor	Kg	Kgf x m ²	B	I	H	H1	H2	H3	H4	H5	H6		
PRA1120/T		2670	836			1650	1250	2120	1570	1400	1320	1800		

Ulteriori informazioni e quote:

- Ulérieures informations et cotes:
- Further information and sizes:
- Weitere Infos und Größen:
- Más informaciones y medidas:

pg. /s. 4.6

pg. /s. 4.5

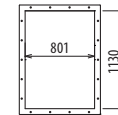
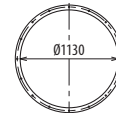

RD0 LG0

RD45 LG45

RD90 LG90

RD135 LG135

RD180 LG180

RD225 LG225

RD270 LG270

RD315 LG315

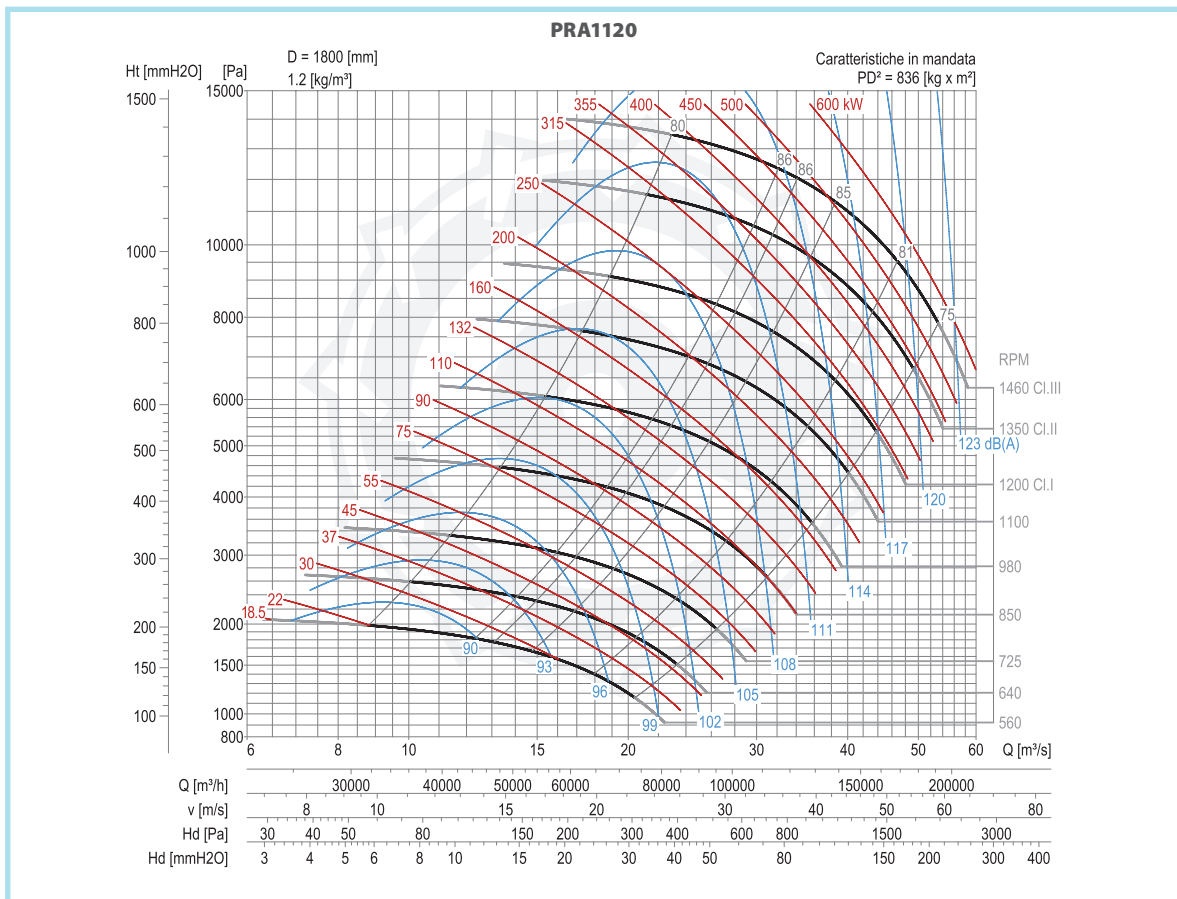

■ DIMENSIONS D'ENCOMBREMENT ET POIDS/COURBES DE FONCTIONNEMENT ■ OVERALL DIMENSIONS AND WEIGHT/WORKING CURVES ■ AUSMAßE UND GEWICHTE/FUNKTIONSKURVEN ■ DIMENSIONES QUE OCUPA Y PESOS/CURVAS DE FUNCIONAMIENTO

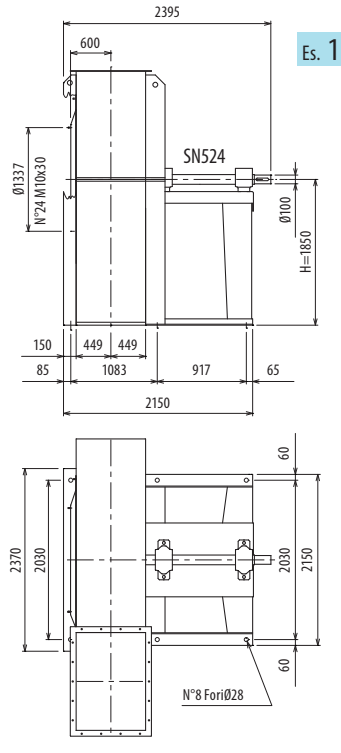

Es. 1

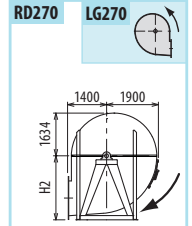
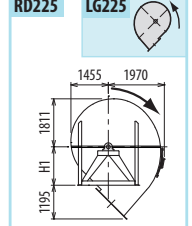
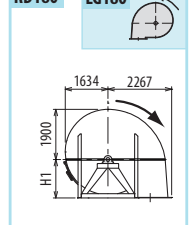
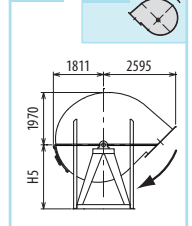
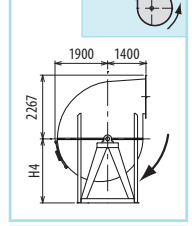
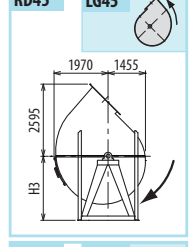
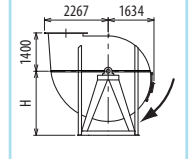
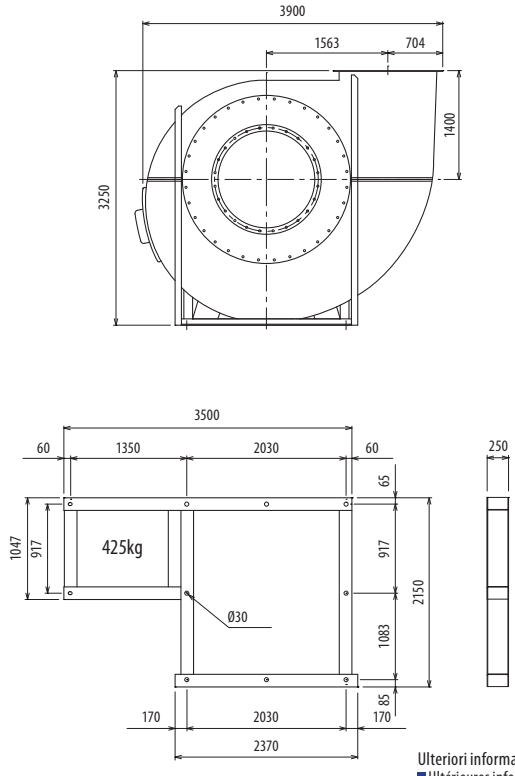

Il ventilatore non è orientabile

■ Le ventilateur n'est pas orientable ■ The fan is not revolvable ■ Der Ventilator ist nicht drehbar ■ El ventilador no es orientable

TIPO - Type		PESO Weight	PD ²	B	I	H	H1	H2	H3	H4	H5	H6
VENTILATORE Fan	MOTORE Motor	Kg	Kgf x m ²									
PRA1250/T		3600	1250			1850	1400	2360	1750	1600	1450	2000

Ulteriori informazioni e quote:
 ■ Ulérieures informations et cotes:
 ■ Further information and sizes:
 ■ Weitere Infos und Größen:
 ■ Más informaciones y medidas:

pg. /s. 4.6
 pg. /s. 4.5

